

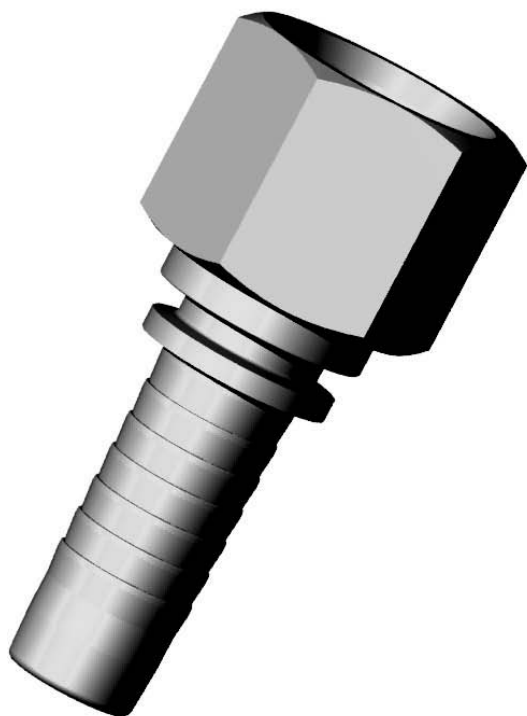

Соединители систем гидравлики и пневматики, изготовленные из нержавеющей стали, для работы в агрессивной окружающей среде и жидкости.

Материал в соответствии с требованиями SS 2343/AISI 316.

Соединители **Hydroscand**, изготовленные из нержавеющей стали, предназначены для работы в системах, использующих





ГРУППА ПРОДУКТА 1000

	Обжимные фитинги Группа продукта 380	Страница
3800-01	Обжимная втулка R1/DIN1	295
3800-02	Обжимная втулка R2/DIN2	295
3800-03	Обжимная втулка R1T	295
3800-04	Обжимная втулка R2AT	295
3800-11	Обжимная втулка, ПТФЭ, 741/742	295
3800-15	Обжимная втулка Euroflow 702/714/722	295
3800-28	Обжимная втулка, ПТФЭ, 741/742	295
3800-30	Обжимная втулка, ПТФЭ, гофрированный рукав	295
3801	G IR	296
3802	G UF	296
3803	G 90° IR	296
3804	G 45° IR	296
3813	JIC IR	297
3814	JIC UF	297
3816	JIC 90° IR	297
3817	JIC 45° IR	297
3820	SKL	297
3823	SKS	297
3826	ST	298
3827	ST 90°	298
3840	NPT UF	298
3841	NPSM IR	298
3844	SAE-фланец 3000 90°	298
3870	DKLO IR	298
3871	DKLO 90°	299
3872	DKLO 45°	299
3873	DKSO IR	299
3874	DKSO 90°	299
3875	DKSO 45°	299
3880	Корпус банджо, резьба G	299
3880-00	Болт банджо, резьба G	299

Мы можем также предложить вам широкий ассортимент многоспиральных и блокировочных фитингов в исполнении из нержавеющей стали. Для получения дополнительной информации свяжитесь с вашим ближайшим офисом Hydroscand.

	Аксессуары, трубные хомуты Группа продукта 500	Страница
5001-21	Фитинг для сжатого воздуха, кулачкового типа, для рукава	300
5001-22	Фитинг для сжатого воздуха, кулачкового типа, внутренняя резьба	300
5001-23	Фитинг для сжатого воздуха, кулачкового типа, наружная резьба	300
5001-04	Уплотнение, витон	300

	Аксессуары, трубные хомуты Группа продукта 510	Страница
5396-0	Сварная пластина HSP, стандартная	301
5396-1	Сварная пластина HSP, длинная	301
5396-2	Двойная сварная пластина HSPD	301
5396-3	Многоэлементная сварная пластина HRSP	301
5398	Направляющая с аксессуарами	301
5396-7	Крышка НТР	301
5397-0	Винт с углублением в головке, H IS	301
5397-3	Болт с шестигранной головкой, H SKB	301
5397-2	Винт секционной пластины, H PBS	301

	Рукавные хомуты и т.д. Группа продукта 560	Страница
5561-10	Рукавный хомут, мини	302
5563	Рукавный хомут	302
5564	Рукавный хомут, DIN	302
5565-20	Рукавный хомут, одиночный	302
5566-20	Рукавный хомут, двойной	302
5601-03	Обрезиненная стальная шайба, G	303
5601-04	Обрезиненная стальная шайба, M	303

Продолжение на следующей странице

	Быстроразъемные фитинги	Страница
Группа продукта 520		
5558-94	Быстроразъемный фитинг Faster	304
5552-75	Быстроразъемный фитинг Tema	304

	Фитинги с врезными кольцами	Страница
Группа продукта 620		
2603	GE - GB	305
2803	GE - GB	305
2606	GE - MB	305
2806	GE - MB	305
2607	GE - NPT	306
2609	GE - G/ED	306
2611	WE - R/C	306
2613	WE - GB	307
2617	WE - NPT	307
2621	TE - R/C	307
2623	TE - GB	307
2641	G	308
2642	W	308
2643	T	308
2644	K	308
2645	SV	309
2646	WSV	309
2647	AS	309
2650	EVW	309
2660	EVT	310
2670	EVL	310
2689	EVGE - G/ED	310
2701	GAI - G	310
2703	MAV - G	311
2704	MAV - EV - G	311
2705	RED	311
2707	KOR - L	312
2907	KOR - S	312
2720	RHD	313
2721	RHV - G - ED	313
2723	RHZ - G - ED	313
2727	RHDI - L	313
2730	PL	314
2747	VH	314
2749	D	314
2750	M	314

	Адаптеры	Страница
Группа продукта 780		
7802	G UF x G UF	315
7805	G UF x G IF, круглый	315
7807	G IR x G IR	315
7808	G UF x G IR	315
7809	G UF x G IF, длинный	315
7810	G UF x G IF, короткий	316
7811	G IF x G IF	316
7812	G UF x R UF	316
7813	G UF x JIC UF	316
7822	G UF x NPT UF	316
7831	G UF x G IR 90T	317
7835	G UF x G IR 90°	317
7836	G UF x R UF 90F	317
7851	G UF x G UF x G UF T	317
7852	G IR x G IR x G IR T	317
7853	G UF x G UF x G IR T	317
7854	G UF x G IR x G UF T	317
7861	G UF ПРОБКА	318
7861-10	R IR ПРОБКА	318
7861-20	G IR ПРОБКА	318
7863	G UF ПРОБКА С УГЛУБЛЕНИЕМ	318
7890	G UF x G UF, переборка	318

	Фитинги под развальцовку	Страница
Группа продукта 790		
7901	Прямой соединительный фитинг	319
7902	Угловой соединительный фитинг	319
7903	T-образный соединительный фитинг	319
7904	Крестовый соединительный фитинг	319
7905	Прямой переборочный фитинг	319
7911	Прямой фитинг – наружная резьба NPTF	319
7913	Прямой фитинг – наружная резьба G	319
7914	Прямой фитинг – наружная резьба UNF с кольцевым уплотнением	320
7920	Угловой фитинг – наружная резьба NPTF	320
7922	Регулируемый угловой фитинг – наружная резьба G (BSP) с кольцевым уплотнением и шайбой	320
7923	Регулируемый угловой фитинг – наружная резьба UNF с кольцевым уплотнением	320
7951	Прямой фитинг – внутренняя резьба G (BSP)	320
7959	Прямой фитинг – стяжная гайка JIC 37° x стяжная гайка JIC 37°	320
7960	Угловой фитинг – со стяжной гайкой JIC 37°	321
7961	Фитинг 45° – со стяжной гайкой JIC 37°	321
7962	T-образный фитинг – со стяжной гайкой JIC 37°	321
7963	L-образный фитинг – со стяжной гайкой JIC 37°	321
7966	Прямой фитинг – стяжная гайка JIC 37° и наружная резьба G (BSP) с кольцевым уплотнением и шайбой	321
7967	Прямой фитинг – стяжная гайка JIC 37° и наружная резьба UNF с кольцевым уплотнением	321
7970	Переходник	322
7981	Измерительное соединение	322
7990	Глухая гайка	322
7991	Пробка	322
7992	Гайка	322
7993	Зажимная втулка	322

	Шаровые клапаны	Страница
Группа продукта 860		
8631	2-ходовой, резьба G (BSP)	323
8632	2-ходовой, резьба M, SKL	323
8634	2-ходовой, резьба M, SKS	323
8641	3-ходовой, реверсивный клапан - L	323
8642	3-ходовой, реверсивный клапан - T	323
8690	2-ходовой, низкое давление	324
8691	3-ходовой, низкое давление	324

	Испытательные ниппели и аксессуары	Страница
8301-90	Испытательный ниппель, резьба G (BSP)	324
8301-94	Испытательный ниппель, резьба UNF	324
8301-95	Испытательный ниппель, резьба NPT	324
8310	Измерительный рукав M16x2,0 – соединение манометра	324
8311	Измерительный рукав M16x2,0	324

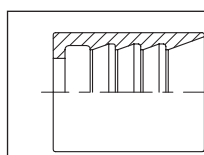

3800-01
ОБЖИМНЫЕ ВТУЛКИ
R1/DIN1
СО СКОСОМ ЗУБЬЕВ
Нержавеющая сталь

Код	Шланг	Внутр. диам. шл.
3800-01-04	EN1SN, 2SC /SF	1/4"
3800-01-06	EN1SN, 2SC /SF	3/8"
3800-01-08	EN1SN, 2SC /SF	1/2"
3800-01-10	EN1SN, 2SC /SF	5/8"
3800-01-12	EN1SN, 2SC /SF	3/4"
3800-01-16	EN1SN, 2SC /SF	1"
3800-01-20	EN1SN, 2SC /SF	1 1/4"
3800-01-24	EN1SN, 2SC /SF	1 1/2"
3800-01-32	EN1SN, 2SC /SF	2"

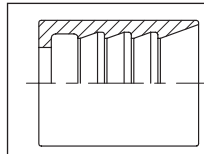

3800-02
ОБЖИМНЫЕ ВТУЛКИ
R2/DIN2
СО СКОСОМ ЗУБЬЕВ
Нержавеющая сталь

Код	Шланг	Внутр. диам. шл.
3800-02-03	EN2SN /SF	3/16"
3800-02-04	EN2SN /SF	1/4"
3800-02-06	EN2SN /SF	3/8"
3800-02-08	EN2SN /SF	1/2"
3800-02-10	EN2SN /SF	5/8"
3800-02-12	EN2SN /SF	3/4"
3800-02-16	EN2SN /SF	1"
3800-02-20	EN2SN /SF	1 1/4"
3800-02-24	EN2SN /SF	1 1/2"
3800-02-32	EN2SN /SF	2"

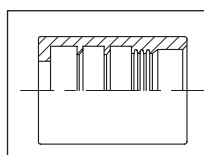

3800-03
ОБЖИМНЫЕ ВТУЛКИ R1 T
БЕЗ СКОСА ЗУБЬЕВ
Нержавеющая сталь

Код	Шланг	Внутр. диам. шл.
3800-03-04	EN1SN, 2SC /SF	1/4"
3800-03-06	EN1SN, 2SC /SF	3/8"
3800-03-08	EN1SN, 2SC /SF	1/2"
3800-03-10	EN1SN, 2SC /SF	5/8"
3800-03-12	EN1SN, 2SC /SF	3/4"
3800-03-16	EN1SN, 2SC /SF	1"
3800-03-20	EN1SN, 2SC /SF	1 1/4"

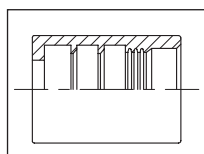

3800-04
ОБЖИМНЫЕ ВТУЛКИ R2 AT
БЕЗ СКОСА ЗУБЬЕВ
Нержавеющая сталь

Код	Шланг	Внутр. диам. шл.
3800-04-04	EN2SN /SF	1/4"
3800-04-06	EN2SN /SF	3/8"
3800-04-08	EN2SN /SF	1/2"
3800-04-10	EN2SN /SF	5/8"
3800-04-12	EN2SN /SF	3/4"
3800-04-16	EN2SN /SF	1"

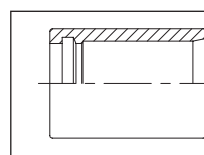

3800-11
ОБЖИМНЫЕ ВТУЛКИ, ПТФЭ
741/742
Нержавеющая сталь

Код	Шланг	Внутр. диам. шл.
3800-11-03	ПТФЭ 741 /SF	3/16"
3800-11-04	ПТФЭ 741 /SF	1/4"
3800-11-05	ПТФЭ 742 /SF	5/16"
3800-11-16	ПТФЭ 741/742 /SF	1"

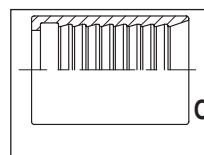

3800-15
ОБЖИМНЫЕ ВТУЛКИ EUROFLOW
702/714/722
Нержавеющая сталь

Код	Шланг	Внутр. диам. шл.
3800-15-03	ТYP 702/714 /SF	3/16"
3800-15-04	ТYP 702/714/722 /SF	1/4"
3800-15-06	ТYP 702/714/722 /SF	3/8"
3800-15-08	ТYP 702/714 /SF	1/2"
3800-15-12	ТYP 702/714 /SF	3/4"
3800-15-16	ТYP 702/714 /SF	1"

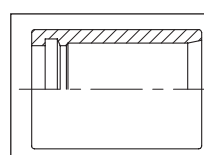

3800-28
ОБЖИМНЫЕ ВТУЛКИ, ПТФЭ
741/742
Нержавеющая сталь

Код	Шланг	Внутр. диам. шл.
3800-28-06	ПТФЭ 741/742 /SF	3/8"
3800-28-08	ПТФЭ 741/742 /SF	1/2"
3800-28-10	ПТФЭ 741/742 /SF	5/8"
3800-28-12	ПТФЭ 741/742 /SF	3/4"

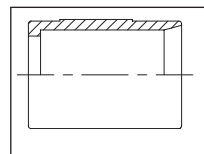

3800-30
ОБЖИМНЫЕ ВТУЛКИ, ПТФЭ
к гофрированным рукавам
Нержавеющая сталь AISI 316

Код	Шланг	Внутр. диам. шл.
3800-30-04	ПТФЭ /SF	1/4"
3800-30-06	ПТФЭ /SF	3/8"
3800-30-08	ПТФЭ /SF	1/2"
3800-30-10	ПТФЭ /SF	5/8"
3800-30-12	ПТФЭ /SF	3/4"
3800-30-16	ПТФЭ /SF	1"
3800-30-20	ПТФЭ /SF	1 1/4"
3800-30-24	ПТФЭ /SF	1 1/2"
3800-30-32	ПТФЭ /SF	2"

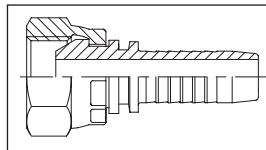

3801

**G IR
Нержавеющая сталь**

Код	Резьба	Тип	Внутр. диам. шл.
3801-04-04	G 1/4"	IR /SF	1/4"
3801-06-06	G 3/8"	IR /SF	3/8"
3801-08-06	G 1/2"	IR /SF	3/8"
3801-08-08	G 1/2"	IR /SF	1/2"
3801-10-10	G 5/8"	IR /SF	5/8"
3801-12-08	G 3/4"	IR /SF	1/2"
3801-12-10	G 3/4"	IR /SF	5/8"
3801-12-12	G 3/4"	IR /SF	3/4"
3801-16-12	G 1"	IR /SF	3/4"
3801-16-16	G 1"	IR /SF	1"
3801-20-20	G 1 1/4"	IR /SF	1 1/4"
3801-24-24	G 1 1/2"	IR /SF	1 1/2"
3801-32-32	G 2"	IR /SF	2"

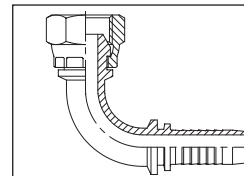

3803

**G 90°
Нержавеющая сталь
Размеры 1/4" – 1",
поставляется цельным**

Код	Резьба	Тип	Внутр. диам. шл.
3803-04-04	G 1/4"	90° /SF	1/4"
3803-06-06	G 3/8"	90° /SF	3/8"
3803-08-06	G 1/2"	90° /SF	3/8"
3803-08-08	G 1/2"	90° /SF	1/2"
3803-10-10	G 5/8"	90° /SF	5/8"
3803-12-10	G 3/4"	90° /SF	5/8"
3803-12-12	G 3/4"	90° /SF	3/4"
3803-16-12	G 1"	90° /SF	3/4"
3803-16-16	G 1"	90° /SF	1"
3803-20-20	G 1 1/4"	90° /SF	1 1/4"
3803-24-24	G 1 1/2"	90° /SF	1 1/2"
3803-32-32	G 2"	90° /SF	2"

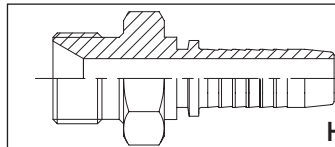

3802

**G UF
Нержавеющая сталь**

Код	Резьба	Тип	Внутр. диам. шл.
3802-04-03	G 1/4"	UF /SF	3/16"
3802-04-04	G 1/4"	UF /SF	1/4"
3802-04-06	G 1/4"	UF /SF	3/8"
3802-06-04	G 3/8"	UF /SF	1/4"
3802-06-06	G 3/8"	UF /SF	3/8"
3802-06-08	G 3/8"	UF /SF	1/2"
3802-08-06	G 1/2"	UF /SF	3/8"
3802-08-08	G 1/2"	UF /SF	1/2"
3802-08-12	G 1/2"	UF /SF	3/4"
3802-10-10	G 5/8"	UF /SF	5/8"
3802-12-12	G 3/4"	UF /SF	3/4"
3802-16-12	G 1"	UF /SF	3/4"
3802-16-16	G 1"	UF /SF	1"
3802-20-20	G 1 1/4"	UF /SF	1 1/4"
3802-24-24	G 1 1/2"	UF /SF	1 1/2"
3802-32-32	G 2"	UF /SF	2"

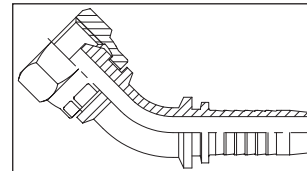

3804

**G 45°
Нержавеющая сталь
Размеры 1/4" – 1",
поставляется цельным**

Код	Резьба	Тип	Внутр. диам. шл.
3804-04-04	G 1/4"	45° /SF	1/4"
3804-06-06	G 3/8"	45° /SF	3/8"
3804-08-08	G 1/2"	45° /SF	1/2"
3804-10-10	G 5/8"	45° /SF	5/8"
3804-12-12	G 3/4"	45° /SF	3/4"
3804-16-16	G 1"	45° /SF	1"
3804-20-20	G 1 1/4"	45° /SF	1 1/4"
3804-24-24	G 1 1/2"	45° /SF	1 1/2"
3804-32-32	G 2"	45° /SF	2"

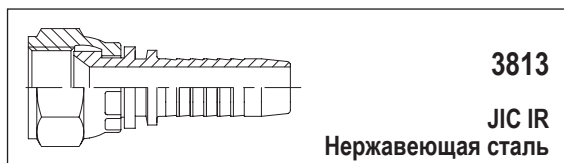

3813

JIC IR
Нержавеющая сталь

Код	Резьба	Тип	Внутр. диам. шл.
3813-07-03	7/16" -20 UNF	JIC IR /SF	3/16"
3813-07-04	7/16" -20 UNF	JIC IR /SF	1/4"
3813-08-04	1/2" -20 UNF	JIC IR /SF	1/4"
3813-09-04	9/16" -18 UNF	JIC IR /SF	1/4"
3813-09-06	9/16" -18 UNF	JIC IR /SF	3/8"
3813-12-06	3/4" -16 UNF	JIC IR /SF	3/8"
3813-12-08	3/4" -16 UNF	JIC IR /SF	1/2"
3813-14-08	7/8" -14 UNF	JIC IR /SF	1/2"
3813-14-10	7/8" -14 UNF	JIC IR /SF	5/8"
3813-17-10	1 1/16" -12 UN	JIC IR /SF	5/8"
3813-17-12	1 1/16" -12 UN	JIC IR /SF	3/4"
3813-21-16	1 5/16" -12 UN	JIC IR /SF	1"
3813-26-20	1 5/8" -12 UN	JIC IR /SF	1 1/4"
3813-30-24	1 7/8" -12 UN	JIC IR /SF	1 1/2"
3813-40-32	2 1/2" -12 UN	JIC IR /SF	2"

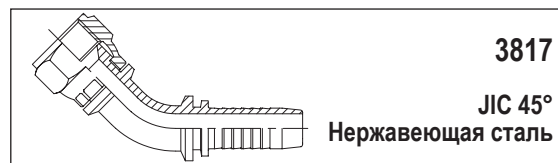

3817

JIC 45°
Нержавеющая сталь

Код	Резьба	Тип	Внутр. диам. шл.
3817-09-06	9/16" -18 UNF	JIC 90° IR /SF	3/8"
3817-12-08	3/4" -16 UNF	JIC 90° IR /SF	1/2"
3817-21-16	1 5/16" -12 UN	JIC 90° IR /SF	1"

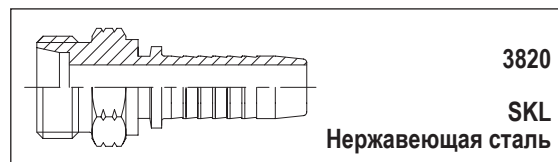

3820

SKL
Нержавеющая сталь

Код	Резьба	Труба	Тип	Внутр. диам. шл.
3820-12-04	M12x1,5	6mm	SKL /SF	1/4"
3820-14-04	M14x1,5	8mm	SKL /SF	1/4"
3820-16-06	M16x1,5	10mm	SKL /SF	3/8"
3820-18-06	M18x1,5	12mm	SKL /SF	3/8"
3820-22-08	M22x1,5	15mm	SKL /SF	1/2"
3820-26-10	M26x1,5	18mm	SKL /SF	5/8"
3820-30-12	M30x2,0	22mm	SKL /SF	3/4"
3820-36-12	M36x2,0	28mm	SKL /SF	3/4"
3820-36-16	M36x2,0	28mm	SKL /SF	1"
3820-45-20	M45x2,0	35mm	SKL /SF	1 1/4"
3820-52-24	M52x2,0	42mm	SKL /SF	1 1/2"

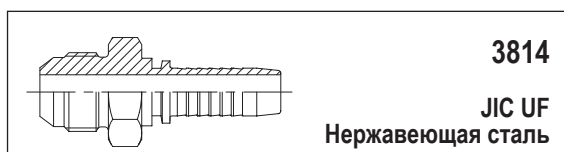

3814

JIC UF
Нержавеющая сталь

Код	Резьба	Тип	Внутр. диам. шл.
3814-07-04	7/16" -20 UNF	JIC UF /SF	1/4"
3814-09-06	9/16" -18 UNF	JIC UF /SF	3/8"
3814-12-06	3/4" -16 UNF	JIC UF /SF	3/8"
3814-12-08	3/4" -16 UNF	JIC UF /SF	1/2"
3814-14-08	7/8" -14 UNF	JIC UF /SF	1/2"
3814-14-10	7/8" -14 UNF	JIC UF /SF	5/8"
3814-17-10	1 1/16" -12 UN	JIC UF /SF	5/8"
3814-17-12	1 1/16" -12 UN	JIC UF /SF	3/4"
3814-21-16	1 5/16" -12 UN	JIC UF /SF	1"
3814-30-20	1 7/8" -12 UN	JIC UF /SF	1 1/4"

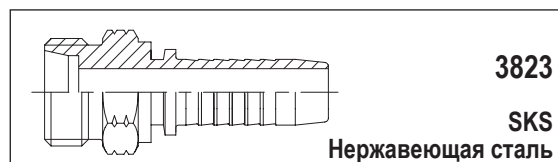

3823

SKS
Нержавеющая сталь

Код	Резьба	Труба	Тип	Внутр. диам. шл.
3823-16-04	M16x1,5	8mm	SKS /SF	1/4"
3823-18-04	M18x1,5	10mm	SKS /SF	1/4"
3823-18-06	M18x1,5	10mm	SKS /SF	3/8"
3823-20-06	M20x1,5	12mm	SKS /SF	3/8"
3823-20-08	M20x1,5	12mm	SKS /SF	1/2"
3823-22-06	M22x1,5	14mm	SKS /SF	3/8"
3823-24-06	M42x1,5	16mm	SKS /SF	3/8"
3823-24-08	M24x1,5	16mm	SKS /SF	1/2"
3823-30-10	M30x1,5	20mm	SKS /SF	5/8"
3823-36-12	M36x2,0	25mm	SKS /SF	3/4"
3823-36-16	M36x2,0	25mm	SKS /SF	1"
3823-42-16	M42x2,0	30mm	SKS /SF	1"
3823-52-20	M52x2,0	38mm	SKS /SF	1 1/4"

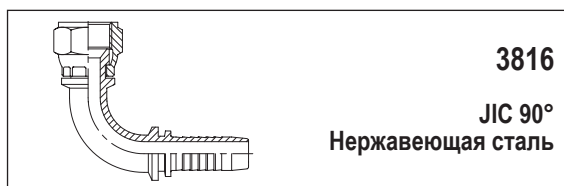

3816

JIC 90°
Нержавеющая сталь

Код	Резьба	Тип	Внутр. диам. шл.
3816-07-04	7/16" -20 UNF	JIC 90° IR /SF	1/4"
3816-08-04	1/2" -12 UNF	JIC 90° IR /SF	1/4"
3816-09-04	9/16" -18 UNF	JIC 90° IR /SF	1/4"
3816-09-06	9/16" -18 UNF	JIC 90° IR /SF	3/8"
3816-12-08	3/4" -16 UNF	JIC 90° IR /SF	1/2"
3816-14-08	7/8" -14 UNF	JIC 90° IR /SF	1/2"
3816-17-08	1 1/16" -12 UN	JIC 90° IR /SF	1/2"
3816-17-10	1 1/16" -12 UN	JIC 90° IR /SF	5/8"
3816-17-12	1 1/16" -12 UN	JIC 90° IR /SF	3/4"
3816-21-16	1 5/16" -12 UN	JIC 90° IR /SF	1"
3816-26-20	1 5/8" -12 UN	JIC 90° IR /SF	1 1/4"
3816-30-24	1 7/8" -12 UN	JIC 90° IR /SF	1 1/2"

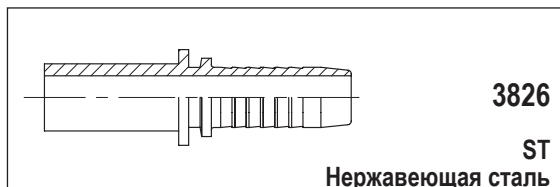

Код	Труба	Тип	Внутр. диам. шл.
3826-06-04	6mm	ST /SF	1/4"
3826-08-03	8mm	ST /SF	3/16"
3826-08-04	8mm	ST /SF	1/4"
3826-10-04	10mm	ST /SF	1/4"
3826-10-06	10mm	ST /SF	3/8"
3826-12-06	12mm	ST /SF	3/8"
3826-12-08	12mm	ST /SF	1/2"
3826-14-06	14mm	ST /SF	3/8"
3826-14-08	14mm	ST /SF	1/2"
3826-15-06	15mm	ST /SF	3/8"
3826-15-08	15mm	ST /SF	1/2"
3826-16-06	16mm	ST /SF	3/8"
3826-16-08	16mm	ST /SF	1/2"
3826-16-16	16mm	ST /SF	1"
3826-18-08	18mm	ST /SF	1/2"
3826-18-10	18mm	ST /SF	5/8"
3826-20-10	20mm	ST /SF	5/8"
3826-20-12	20mm	ST /SF	3/4"
3826-20-20	20mm	ST /SF	1 1/4"
3826-22-12	22mm	ST /SF	3/4"
3826-25-12	25mm	ST /SF	3/4"
3826-28-16	28mm	ST /SF	1"
3826-30-16	30mm	ST /SF	1"
3826-35-20	35mm	ST /SF	1 1/4"
3826-38-20	38mm	ST /SF	1 1/4"
3826-42-24	42mm	ST /SF	1 1/2"

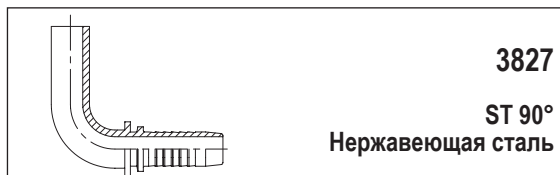

Код	Труба	Тип	Внутр. диам. шл.
3827-06-04	6mm	ST /SF	1/4"
3827-08-04	8mm	ST /SF	1/4"
3827-10-04	10mm	ST /SF	1/4"
3827-10-06	10mm	ST /SF	3/8"
3827-12-06	12mm	ST /SF	3/8"
3827-15-08	15mm	ST /SF	1/2"
3827-18-08	18mm	ST /SF	1/2"

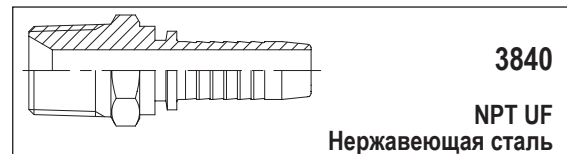

Код	Резьба	Тип	Внутр. диам. шл.
3840-04-04	1/4" -18 NPT	UF /SF	1/4"
3840-06-06	3/8" -18 NPT	UF /SF	3/8"
3840-08-08	1/2" -14 NPT	UF /SF	1/2"
3840-12-12	3/4" -14 NPT	UF /SF	3/4"
3840-16-16	1" -11 1/2 NPT	UF /SF	1"
3840-20-20	1 1/4" -11 1/2 NPT	UF /SF	1 1/4"

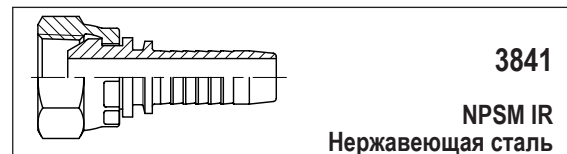

Код	Резьба	Тип	Внутр. диам. шл.
3841-04-03	1/4"	-18 NPSM IR /SF	3/16"
3841-04-04	3/8"	-18 NPSM IR /SF	1/4"

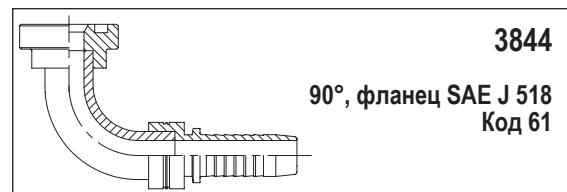

Код	Фланец	Тип	Внутр. диам. шл.
3844-20-16	1 1/4"	90° S61 /SF	1"
3844-20-20	1 1/4"	90° S61 /SF	1 1/4"
3844-24-24	1 1/2"	90° S61 /SF	1 1/2"

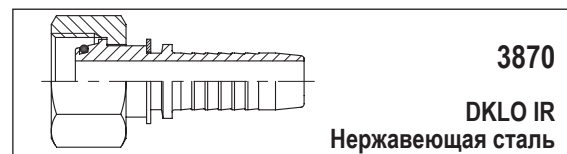

Код	Резьба	Труба	Тип	Внутр. диам. шл.
3870-06-04	M12x1,5	6mm	DKLO /SF	1/4"
3870-08-04	M14x1,5	8mm	DKLO /SF	1/4"
3870-08-06	M14x1,5	8mm	DKLO /SF	3/8"
3870-10-04	M16x1,5	10mm	DKLO /SF	1/4"
3870-10-06	M16x1,5	10mm	DKLO /SF	3/8"
3870-12-04	M18x1,5	12mm	DKLO /SF	1/4"
3870-12-06	M18x1,5	12mm	DKLO /SF	3/8"
3870-15-08	M22x1,5	15mm	DKLO /SF	1/2"
3870-18-08	M26x1,5	18mm	DKLO /SF	1/2"
3870-18-10	M26x1,5	18mm	DKLO /SF	5/8"
3870-22-12	M30x2,0	22mm	DKLO /SF	3/4"
3870-22-16	M30x2,0	22mm	DKLO /SF	1"
3870-28-16	M36x2,0	28mm	DKLO /SF	1"
3870-35-20	M45x2,0	35mm	DKLO /SF	1 1/4"

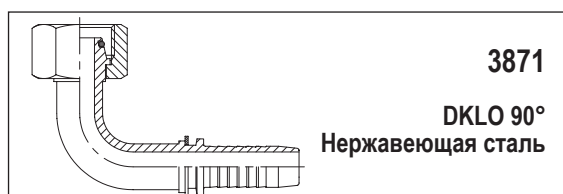

3871

DKLO 90°
Нержавеющая сталь

Код Резьба Труба Тип Внутр. диам. шл.

3871-08-04	M14x1,5	8mm	DKLO 90° /SF	1/4"
3871-10-04	M16x1,5	10mm	DKLO 90° /SF	1/4"
3871-10-06	M16x1,5	10mm	DKLO 90° /SF	3/8"
3871-12-06	M18x1,5	12mm	DKLO 90° /SF	3/8"
3871-15-08	M22x1,5	15mm	DKLO 90° /SF	1/2"
3871-18-08	M26x1,5	18mm	DKLO 90° /SF	1/2"
3871-18-10	M26x1,5	18mm	DKLO 90° /SF	5/8"
3871-18-12	M26x1,5	18mm	DKLO 90° /SF	3/4"
3871-22-12	M30x2,0	22mm	DKLO 90° /SF	3/4"
3871-28-16	M36x2,0	28mm	DKLO 90° /SF	1"
3871-35-20	M45x2,0	35mm	DKLO 90° /SF	1 1/4"

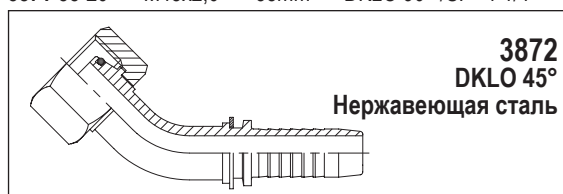

3872

DKLO 45°
Нержавеющая сталь

Код Резьба Труба Тип Внутр. диам. шл.

3872-08-04	M14	8mm	DKLO 45° /SF	1/4"
3872-12-06	M18	12mm	DKLO 45° /SF	3/8"
3872-15-08	M22	15mm	DKLO 45° /SF	1/2"
3872-18-10	M26	18mm	DKLO 45° /SF	5/8"
3872-22-12	M30	22mm	DKLO 45° /SF	3/4"
3872-28-16	M36	28mm	DKLO 45° /SF	1"
3872-35-20	M45	35mm	DKLO 45° /SF	1 1/4"

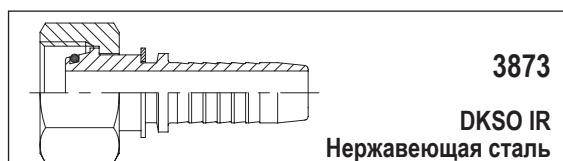

3873

DKSO IR
Нержавеющая сталь

Код Резьба Труба Тип Внутр. диам. шл.

3873-06-04	M14x1,5	6mm	DKSO /SF	1/4"
3873-08-04	M16x1,5	8mm	DKSO /SF	1/4"
3873-10-04	M18x1,5	10mm	DKSO /SF	1/4"
3873-10-06	M18x1,5	10mm	DKSO /SF	3/8"
3873-12-04	M20x1,5	12mm	DKSO /SF	1/4"
3873-12-06	M20x1,5	12mm	DKSO /SF	3/8"
3873-14-06	M22x1,5	14mm	DKSO /SF	3/8"
3873-16-06	M24x1,5	16mm	DKSO /SF	3/8"
3873-16-08	M24x1,5	16mm	DKSO /SF	1/2"
3873-16-10	M24x1,5	16mm	DKSO /SF	5/8"
3873-20-10	M30x2,0	20mm	DKSO /SF	5/8"
3873-20-12	M30x2,0	20mm	DKSO /SF	3/4"
3873-25-12	M36x2,0	25mm	DKSO /SF	3/4"
3873-25-16	M36x2,0	25mm	DKSO /SF	1"
3873-30-16	M42x2,0	30mm	DKSO /SF	1"
3873-30-20	M42x2,0	30mm	DKSO /SF	1 1/4"
3873-38-20	M52x2,0	38mm	DKSO /SF	1 1/4"

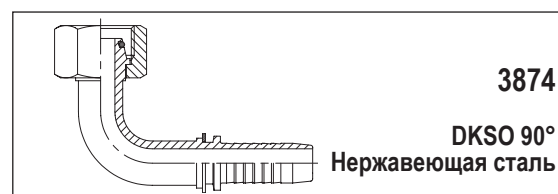

3874

DKSO 90°
Нержавеющая сталь

Код Резьба Труба Тип Внутр. диам. шл.

3874-08-04	M16x1,5	8mm	DKSO 90° /SF	1/4"
3874-10-04	M18x1,5	10mm	DKSO 90° /SF	1/4"
3874-10-06	M18x1,5	10mm	DKSO 90° /SF	3/8"
3874-12-06	M20x1,5	12mm	DKSO 90° /SF	3/8"
3874-14-06	M22x1,5	14mm	DKSO 90° /SF	3/8"
3874-16-08	M24x1,5	16mm	DKSO 90° /SF	1/2"
3874-20-10	M30x2,0	20mm	DKSO 90° /SF	5/8"
3874-20-12	M30x2,0	20mm	DKSO 90° /SF	3/4"
3874-25-12	M36x2,0	25mm	DKSO 90° /SF	3/4"
3874-25-16	M36x2,0	25mm	DKSO 90° /SF	1"
3874-30-16	M42x2,0	30mm	DKSO 90° /SF	1"
3874-38-20	M52x2,0	38mm	DKSO 90° /SF	1 1/4"

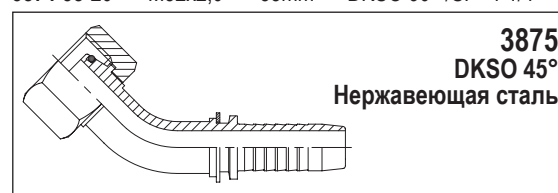

3875

DKSO 45°
Нержавеющая сталь

Код Резьба Труба Тип Внутр. диам. шл.

3875-10-04	M18x1,5	10mm	DKSO 45° /SF	1/4"
3875-12-06	M20x1,5	12mm	DKSO 45° /SF	3/8"
3875-14-06	M22x1,5	14mm	DKSO 45° /SF	3/8"
3875-16-08	M24x1,5	16mm	DKSO 45° /SF	1/2"
3875-20-10	M30x2,0	20mm	DKSO 45° /SF	5/8"
3875-25-12	M36x2,0	25mm	DKSO 45° /SF	3/4"
3875-30-16	M42x2,0	30mm	DKSO 45° /SF	1"
3875-38-20	M52x2,0	38mm	DKSO 45° /SF	1 1/4"

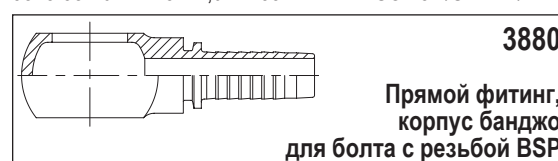

3880

Прямой фитинг,
корпус банджо
для болта с резьбой BSP

Код Резьба протяннутая Внутр. диам. шл. Высота

3880-04-04	1/4"	1/4"	14,5mm
3880-06-06	3/8"	3/8"	17,0mm
3880-08-08	1/2"	1/2"	22,0mm



3880-00

Болт с резьбой G для
банджо BSP

Код Резьба Длина

3880-00-04	1/4"	25mm
3880-00-06	3/8"	31mm
3880-00-08	1/2"	38mm



Код	Тип	Внутр. диам. шл.
5001-21-06	Нержавеющая сталь	3/8"
5001-21-08	Нержавеющая сталь	1/2"
5001-21-12	Нержавеющая сталь	3/4"
5001-21-16	Нержавеющая сталь	1"



Код	Тип	Резьба
5001-23-08	Нержавеющая сталь	G 1/2" UF
5001-23-12	Нержавеющая сталь	G 3/4" UF
5001-23-16	Нержавеющая сталь	G 1" UF



Код	Тип	Внутр. диам. шл.
5001-22-08	Нержавеющая сталь	G 1/2" IF
5001-22-12	Нержавеющая сталь	G 3/4" IF
5001-22-16	Нержавеющая сталь	G 1" IF



Код
5001-04-02

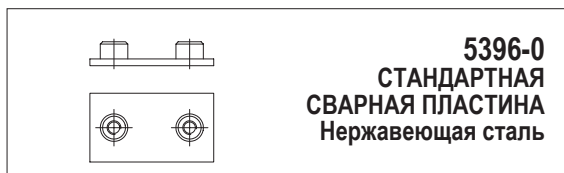

5396-0
СТАНДАРТНАЯ
СВАРНАЯ ПЛАСТИНА
Нержавеющая сталь

Код	Изделие	Группа
5396-01-01	H SP /SF	1
5396-02-01	H SP /SF	2
5396-03-01	H SP /SF	3
5396-04-01	H SP /SF	4
5396-05-01	H SP /SF	5
5396-06-01	H SP /SF	6
5396-07-01	H SP /SF	7

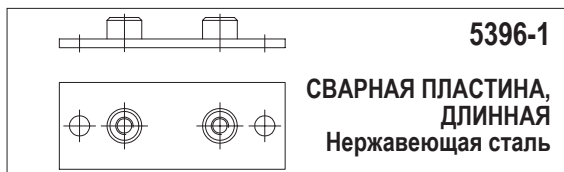

5396-1
СВАРНАЯ ПЛАСТИНА,
ДЛИННАЯ
Нержавеющая сталь

Код	Изделие	Группа
5396-12-01	H SP /SF - длинная	2
5396-13-01	H SP /SF - длинная	3
5396-14-01	H SP /SF - длинная	4
5396-15-01	H SP /SF - длинная	5
5396-16-01	H SP /SF - длинная	6

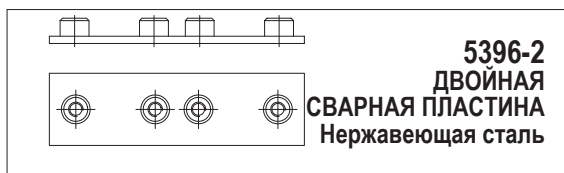

5396-2
ДВОЙНАЯ
СВАРНАЯ ПЛАСТИНА
Нержавеющая сталь

Код	Изделие	Группа
5396-22-02	H SPD /SF	2
5396-23-02	H SPD /SF	3
5396-24-02	H SPD /SF	4
5396-25-02	H SPD /SF	5



5396-3
МНОГОЭЛЕМЕНТНАЯ СВАРНАЯ ПЛАСТИНА
Коррозионностойкая

Код	Изделие	Группа	Хомута, кол.
5396-31-10	H RSP /SF	1	10
5396-32-10	H RSP /SF	2	10
5396-33-10	H RSP /SF	3	10
5396-34-10	H RSP /SF	4	10
5396-35-05	H RSP /SF	5	5

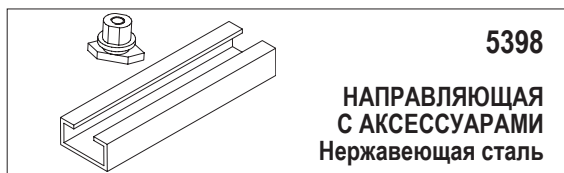

5398
НАПРАВЛЯЮЩАЯ
С АКСЕССУАРАМИ
Нержавеющая сталь

Код	Изделие
5398-00-05	H BS/SF
5398-00-02	H FM/SF
5393-00-03	уплотнение для H FM



5396-7
СЕКЦИОННАЯ ПЛАСТИНА
Нержавеющая сталь

Код	Изделие	Группа
5396-71-01	H TP /SF	1
5396-72-01	H TP /SF	2
5396-73-01	H TP /SF	3
5396-74-01	H TP /SF	4
5396-75-01	H TP /SF	5
5396-76-01	H TP /SF	6
5396-77-01	H TP /SF	7



5397-0
ВИНТ С УГЛУБЛЕНИЕМ
В ГОЛОВКЕ
Нержавеющая сталь

Код	Изделие	Резьба	Длина	Группа
5397-01-22	H IS /SF	M6	22	1 & 2
5397-03-28	H IS /SF	M6	28	3
5397-04-30	H IS /SF	M6	30	4
5397-05-40	H IS /SF	M6	40	5
5397-06-50	H IS /SF	M6	50	6
5397-07-60	H IS /SF	M6	60	7
5397-00-01	Шайба для M6			

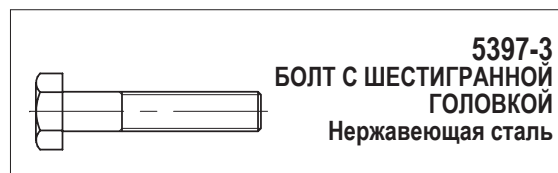

5397-3
БОЛТ С ШЕСТИГРАННОЙ
ГОЛОВКОЙ
Нержавеющая сталь

Код	Изделие	Резьба	Длина	Группа
5397-31-30	H SKB /SF	M6	30	1 & 2
5397-33-35	H SKB /SF	M6	35	3
5397-34-40	H SKB /SF	M6	40	4
5397-35-50	H SKB /SF	M6	50	5
5397-36-60	H SKB /SF	M6	60	6
5397-37-70	H SKB /SF	M6	70	7

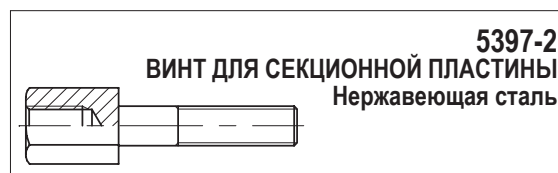

5397-2
ВИНТ ДЛЯ СЕКЦИОННОЙ ПЛАСТИНЫ
Нержавеющая сталь

Код	Изделие	Резьба	Длина	Группа
5397-21-22	H PBS /SF	M6	22	1 & 2
5397-23-28	H PBS /SF	M6	27	3
5397-24-30	H PBS /SF	M6	29	4
5397-25-40	H PBS /SF	M6	39	5
5397-00-04	Шайба уплотнительная SF			



5561-10

DIN
Рукавный хомут Мини
Нержавеющая сталь, AISI 304
Ширина ленты 12 мм

Код	Изделие	Интервал	Ширина ленты
5561-10-08	RF	7,5 - 8,5mm	12mm
5561-10-09	RF	8,5 - 9,5mm	12mm
5561-10-10	RF	9,5 - 11mm	12mm
5561-10-11	RF	10,5 - 12mm	12mm
5561-10-12	RF	11,5 - 13mm	12mm
5561-10-13	RF	12,5 - 14mm	12mm
5561-10-14	RF	13,5 - 15mm	12mm
5561-10-15	RF	14,5 - 16mm	12mm
5561-10-16	RF	15 - 17mm	12mm
5561-10-17	RF	16 - 18mm	12mm



5564

РУКАВНЫЙ ХОМУТ
НЕРЖАВЕЮЩАЯ СТАЛЬ
DIN

Код	Интервал	Ширина ленты
5564-08-16	8 - 16mm	9mm
5564-12-22	12 - 22mm	9mm
5564-16-25	16 - 25mm	12mm
5564-23-35	23 - 35mm	12mm
5564-25-40	25 - 40mm	12mm
5564-30-45	30 - 45mm	12mm
5564-32-50	32 - 50mm	12mm
5564-40-60	40 - 60mm	12mm
5564-50-70	50 - 70mm	12mm
5564-60-80	60 - 80mm	12mm
5564-70-90	70 - 90mm	12mm
5564-01-00	80 - 100mm	12mm
5564-01-10	90 - 110mm	12mm
5564-01-20	100 - 120mm	12mm
5564-01-30	110 - 130mm	12mm
5564-01-40	120 - 140mm	12mm
5564-01-50	130 - 150mm	12mm
5564-01-60	140 - 160mm	12mm
5564-01-70	150 - 170mm	12mm
5564-01-80	160 - 180mm	12mm

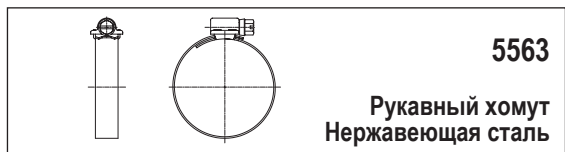

5563

Рукавный хомут
Нержавеющая сталь

Код	Интервал	Ширина ленты
5563-08-14	8 - 14mm	9mm
5563-11-17	11 - 17mm	9mm
5563-13-20	13 - 20mm	9mm
5563-15-24	15 - 24mm	12mm
5563-19-28	19 - 28mm	12mm
5563-22-32	22 - 32mm	12mm
5563-26-38	26 - 38mm	12mm
5563-32-44	32 - 44mm	12mm
5563-38-50	38 - 50mm	12mm
5563-44-56	44 - 56mm	12mm
5563-50-65	50 - 65mm	12mm
5563-58-75	58 - 75mm	12mm
5563-68-85	68 - 85mm	12mm
5563-77-95	77 - 95mm	12mm
5563-91-12	87 - 112mm	12mm
5563-91-38	104 - 138mm	12mm
5563-91-65	130 - 165mm	12mm
5563-91-80	150 - 180mm	12mm
5563-92-05	175 - 205mm	12mm

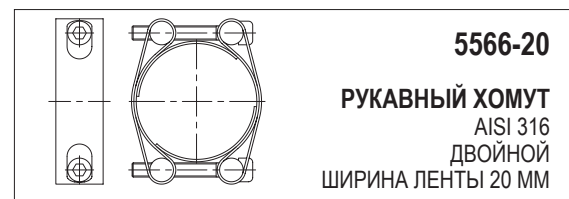

5566-20

РУКАВНЫЙ ХОМУТ
AISI 316
ДВОЙНОЙ
ШИРИНА ЛЕНТЫ 20 мм

Код	Изделие	Интервал	Ширина ленты
5566-20-50	SF 50D20	40 - 50mm	20mm
5566-20-55	SF 55D20	45 - 55mm	20mm
5566-20-60	SF 60D20	50 - 60mm	20mm
5566-20-65	SF 65D20	55 - 65mm	20mm
5566-20-70	SF 70D20	60 - 70mm	20mm
5566-20-75	SF 75D20	65 - 75mm	20mm
5566-20-80	SF 80D20	70 - 80mm	20mm
5566-20-85	SF 85D20	75 - 85mm	20mm
5566-20-90	SF 90D20	80 - 90mm	20mm
5566-20-95	SF 95D20	85 - 95mm	20mm
5566-21-00	SF 100D20	90 - 100mm	20mm
5566-21-05	SF 105D20	95 - 105mm	20mm
5566-21-10	SF 110D20	100 - 110mm	20mm
5566-21-15	SF 115D20	105 - 115mm	20mm
5566-21-20	SF 120D20	110 - 120mm	20mm
5566-21-25	SF 125D20	115 - 125mm	20mm
5566-21-30	SF 130D20	120 - 130mm	20mm
5566-21-35	SF 135D20	125 - 135mm	20mm
5566-21-40	SF 140D20	130 - 140mm	20mm
5566-21-45	SF 145D20	135 - 145mm	20mm
5566-21-50	SF 150D20	140 - 150mm	20mm
5566-21-60	SF 160D20	150 - 160mm	20mm

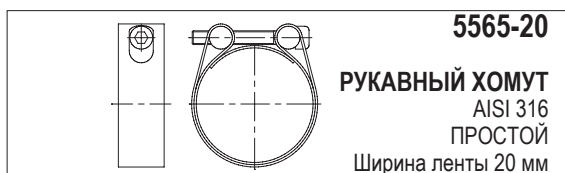

5565-20

РУКАВНЫЙ ХОМУТ
AISI 316
ПРОСТОЙ
Ширина ленты 20 мм

Код	Изделие	Интервал	Ширина ленты
5565-20-40	SF 40E20	35 - 40mm	20mm
5565-20-45	SF 45E20	39 - 45mm	20mm
5565-20-50	SF 50E20	44 - 50mm	20mm
5565-20-55	SF 55E20	49 - 55mm	20mm
5565-20-60	SF 60E20	54 - 60mm	20mm
5565-20-65	SF 65E20	59 - 65mm	20mm
5565-20-70	SF 70E20	64 - 70mm	20mm



Код	Для резьбы:
5601-03-02	G 1/8"
5601-03-04	G 1/4"
5601-03-06	G 3/8"
5601-03-08	G 1/2"
5601-03-10	G 5/8"
5601-03-12	G 3/4"
5601-03-16	G 1"
5601-03-20	G 1 1/4"
5601-03-24	G 1 1/2"
5601-03-32	G 2"



Код	Для резьбы:
5601-04-04	M4
5601-04-05	M5
5601-04-06	M6
5601-04-08	M8
5601-04-10	M10
5601-04-12	M12
5601-04-14	M14
5601-04-16	M16
5601-04-18	M18
5601-04-20	M20
5601-04-22	M22
5601-04-24	M24

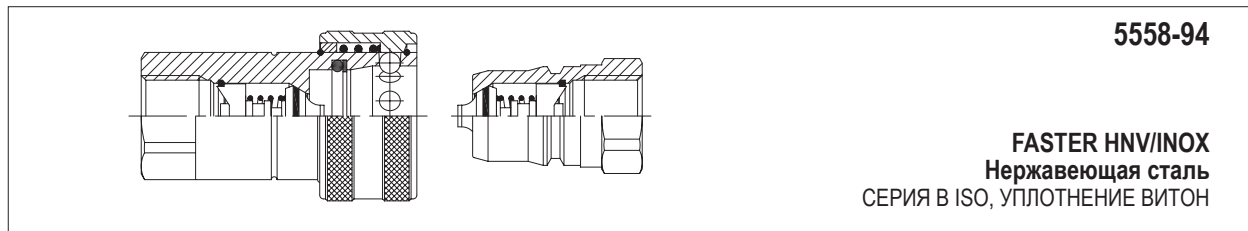

Размер	Код (папа)	Код (мама)	Раб. давл., МПа	Резьба	Поток л/мин	Сборочная длина
1/4"	5558-95-04	5558-96-04	35,0	G 1/4" IF	12	70,5mm
3/8"	5558-95-06	5558-96-06	30,0	G 3/8" IF	30	82,5mm
1/2"	5558-95-08	5558-96-08	30,0	G 1/2" IF	50	92,5mm
3/4"	5558-95-12	5558-96-12	25,0	G 3/4" IF	110	111,0mm
1"	5558-95-16	5558-96-16	23,0	G 1" IF	160	133,0mm

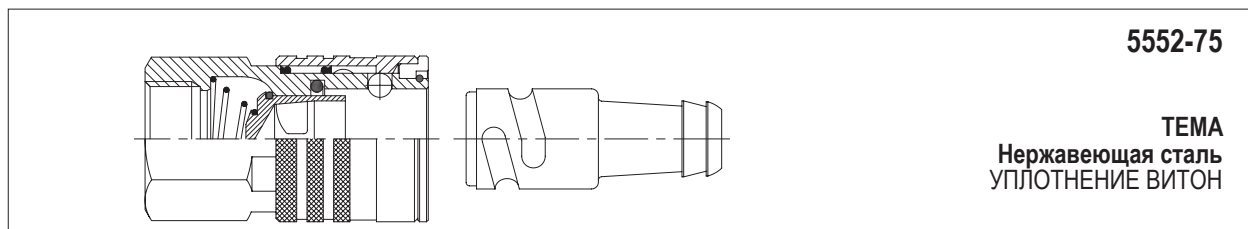

Размер	ТЕМА		ТЕМА		Раб. давл., МПа	Резьба	Поток л/мин	Сборочная длина
	Код (папа)	Изделие	Код (мама)	Изделие				
1/4"	5T2520RV	2520RV	5T2510RV	2510RV	45,0	G 1/4" IF	19	81,0mm
3/8"	5T3820RV	3820RV	5T3810RV	3810RV	35,0	G 3/8" IF	40	74,0mm
1/2"	5T5020RV	5020RV	5T5010RV	5010RV	30,0	G 1/2" IF	85	82,0mm
3/4"	5T7520RV	7520RV	5T7510RV	7510RV	28,0	G 3/4" IF	160	91,0mm
1"	5T10020RV	10020RV	5T10010RV	10010RV	25,0	G 1" IF	225	108,0mm



Код	Тип	Труба мм	Резьба
2603-06-02	GE 6 L /SF	6mm	G 1/8" UF
2603-06-04	GE 6 L /SF	6mm	G 1/4" UF
2603-06-06	GE 6 L /SF	6mm	G 3/8" UF
2603-06-08	GE 6 L /SF	6mm	G 1/2" UF
2603-08-02	GE 8 L /SF	8mm	G 1/8" UF
2603-08-04	GE 8 L /SF	8mm	G 1/4" UF
2603-08-06	GE 8 L /SF	8mm	G 3/8" UF
2603-08-08	GE 8 L /SF	8mm	G 1/2" UF
2603-10-04	GE 10 L /SF	10mm	G 1/4" UF
2603-10-06	GE 10 L /SF	10mm	G 3/8" UF
2603-10-08	GE 10 L /SF	10mm	G 1/2" UF
2603-12-04	GE 12 L /SF	12mm	G 1/4" UF
2603-12-06	GE 12 L /SF	12mm	G 3/8" UF
2603-12-08	GE 12 L /SF	12mm	G 1/2" UF
2603-12-12	GE 12 L /SF	12mm	G 3/4" UF
2603-15-06	GE 15 L /SF	15mm	G 3/8" UF
2603-15-08	GE 15 L /SF	15mm	G 1/2" UF
2603-15-12	GE 15 L /SF	15mm	G 3/4" UF
2603-18-06	GE 18 L /SF	18mm	G 3/8" UF
2603-18-08	GE 18 L /SF	18mm	G 1/2" UF
2603-18-12	GE 18 L /SF	18mm	G 3/4" UF
2603-22-08	GE 22 L /SF	22mm	G 1/2" UF
2603-22-12	GE 22 L /SF	22mm	G 3/4" UF
2603-22-16	GE 22 L /SF	22mm	G 1" UF
2603-28-12	GE 28 L /SF	28mm	G 3/4" UF
2603-28-16	GE 28 L /SF	28mm	G 1" UF
2603-28-20	GE 28 L /SF	28mm	G 1 1/4" UF
2603-35-16	GE 35 L /SF	35mm	G 1" UF
2603-35-20	GE 35 L /SF	35mm	G 1 1/4" UF
2603-35-24	GE 35 L /SF	35mm	G 1 1/2" UF
2603-42-20	GE 42 L /SF	42mm	G 1 1/4" UF
2603-42-24	GE 42 L /SF	42mm	G 1 1/2" UF



Код	Тип	Труба мм	Резьба
2803-06-04	GE 6 S /SF	6mm	G 1/4" UF
2803-06-06	GE 6 S /SF	6mm	G 3/8" UF
2803-06-08	GE 6 S /SF	6mm	G 1/2" UF
2803-08-02	GE 8 S /SF	8mm	G 1/8" UF
2803-08-04	GE 8 S /SF	8mm	G 1/4" UF
2803-08-06	GE 8 S /SF	8mm	G 3/8" UF
2803-08-08	GE 8 S /SF	8mm	G 1/2" UF
2803-10-04	GE 10 S /SF	10mm	G 1/4" UF
2803-10-06	GE 10 S /SF	10mm	G 3/8" UF
2803-10-08	GE 10 S /SF	10mm	G 1/2" UF
2803-12-04	GE 12 S /SF	12mm	G 1/4" UF
2803-12-06	GE 12 S /SF	12mm	G 3/8" UF
2803-12-08	GE 12 S /SF	12mm	G 1/2" UF
2803-14-06	GE 14 S /SF	14mm	G 3/8" UF
2803-14-08	GE 14 S /SF	14mm	G 1/2" UF
2803-16-06	GE 16 S /SF	16mm	G 3/8" UF
2803-16-08	GE 16 S /SF	16mm	G 1/2" UF
2803-16-12	GE 16 S /SF	16mm	G 3/4" UF
2803-20-08	GE 20 S /SF	20mm	G 1/2" UF
2803-20-12	GE 20 S /SF	20mm	G 3/4" UF
2803-20-16	GE 20 S /SF	20mm	G 1" UF
2803-25-12	GE 25 S /SF	25mm	G 3/4" UF
2803-25-16	GE 25 S /SF	25mm	G 1" UF
2803-25-20	GE 25 S /SF	25mm	G 1 1/4" UF
2803-30-16	GE 30 S /SF	30mm	G 1" UF
2803-30-20	GE 30 S /SF	30mm	G 1 1/4" UF
2803-30-24	GE 30 S /SF	30mm	G 1 1/2" UF
2803-38-16	GE 38 S /SF	38mm	G 1" UF
2803-38-20	GE 38 S /SF	38mm	G 1 1/4" UF
2803-38-24	GE 38 S /SF	38mm	G 1 1/2" UF



Код	Тип	Труба мм	Резьба
2606-06-10	GE 6 L /SF	6mm	M10 x 1,0
2606-08-12	GE 8 L /SF	8mm	M12 x 1,5
2606-10-14	GE 10 L /SF	10mm	M14 x 1,5
2606-12-14	GE 12 L /SF	12mm	M14 x 1,5
2606-12-16	GE 12 L /SF	12mm	M16 x 1,5
2606-15-18	GE 15 L /SF	15mm	M18 x 1,5
2606-18-22	GE 18 L /SF	18mm	M22 x 1,5
2606-22-26	GE 22 L /SF	22mm	M26 x 1,5
2606-28-33	GE 28 L /SF	28mm	M33 x 2,0
2606-35-42	GE 35 L /SF	35mm	M42 x 2,0
2606-42-48	GE 42 L /SF	42mm	M48 x 2,0



Код	Тип	Труба мм	Резьба
2806-06-12	GE 6 S /SF	6mm	M12 x 1,5
2806-08-14	GE 8 S /SF	8mm	M14 x 1,5
2806-10-16	GE 10 S /SF	10mm	M16 x 1,5
2806-12-18	GE 12 S /SF	12mm	M18 x 1,5
2806-14-20	GE 14 S /SF	14mm	M20 x 1,5
2806-16-22	GE 16 S /SF	16mm	M22 x 1,5
2806-25-33	GE 25 S /SF	25mm	M33 x 2,0
2806-30-42	GE 30 S /SF	30mm	M42 x 2,0
2806-38-48	GE 38 S /SF	38mm	M48 x 2,0



Код	Тип	Труба мм	Резьба
2607-06-02	GE 6 L /SF	6mm	1/8"- 27 NPT
2607-06-04	GE 6 L /SF	6mm	1/4"- 18 NPT
2607-06-06	GE 6 L /SF	6mm	3/8"- 18 NPT
2607-06-08	GE 6 L /SF	6mm	1/2"- 14 NPT
2607-08-02	GE 8 L /SF	8mm	1/8"- 27 NPT
2607-08-04	GE 8 L /SF	8mm	1/4"- 18 NPT
2607-08-06	GE 8 L /SF	8mm	3/8"- 18 NPT
2607-08-08	GE 8 L /SF	8mm	1/2"- 14 NPT
2607-10-02	GE 10 L /SF	10mm	1/8"- 27 NPT
2607-10-04	GE 10 L /SF	10mm	1/4"- 18 NPT
2607-10-06	GE 10 L /SF	10mm	3/8"- 18 NPT
2607-10-08	GE 10 L /SF	10mm	1/2"- 14 NPT
2607-12-04	GE 12 L /SF	12mm	1/4"- 18 NPT
2607-12-06	GE 12 L /SF	12mm	3/8"- 18 NPT
2607-12-08	GE 12 L /SF	12mm	3/8"- 18 NPT
2607-12-12	GE 12 L /SF	12mm	3/4"- 14 NPT
2607-15-08	GE 15 L /SF	15mm	1/2"- 14 NPT
2607-15-12	GE 15 L /SF	15mm	3/4"- 14 NPT
2607-18-08	GE 18 L /SF	18mm	1/2"- 14 NPT
2607-22-08	GE 22 L /SF	22mm	1/2"- 14 NPT
2607-22-12	GE 22 L /SF	22mm	3/4"- 14 NPT
2607-28-16	GE 28 L /SF	28mm	1"- 11½ NPT
2607-35-20	GE 35 L /SF	35mm	1 1/4"- 11½ NPT
2607-42-24	GE 42 L /SF	42mm	1 1/2"- 11½ NPT
2807-06-04	GE 6 S /SF	6mm	1/4"- 18 NPT
2807-06-06	GE 6 S /SF	6mm	3/8"- 18 NPT
2807-06-08	GE 6 S /SF	6mm	1/2"- 14 NPT
2807-08-04	GE 8 S /SF	8mm	1/4"- 18 NPT
2807-08-06	GE 8 S /SF	8mm	3/8"- 18 NPT
2807-08-08	GE 8 S /SF	8mm	1/2"- 14 NPT
2807-10-04	GE 10 S /SF	10mm	1/4"- 18 NPT
2807-10-06	GE 10 S /SF	10mm	3/8"- 18 NPT
2807-10-08	GE 10 S /SF	10mm	1/2"- 14 NPT
2807-12-04	GE 12 S /SF	12mm	1/4"- 18 NPT
2807-12-06	GE 12 S /SF	12mm	3/8"- 18 NPT
2807-12-08	GE 12 S /SF	12mm	1/2"- 14 NPT
2807-14-08	GE 14 S /SF	14mm	1/2"- 14 NPT
2807-16-06	GE 16 S /SF	16mm	3/8"- 18 NPT
2807-16-08	GE 16 S /SF	16mm	1/2"- 14 NPT
2807-16-12	GE 16 S /SF	16mm	3/4"- 14 NPT
2807-20-08	GE 20 S /SF	20mm	1/2"- 14 NPT
2807-20-12	GE 20 S /SF	20mm	3/4"- 14 NPT
2807-25-12	GE 25 S /SF	25mm	3/4"- 14 NPT
2807-25-16	GE 25 S /SF	25mm	1"- 11½ NPT
2807-30-16	GE 30 S /SF	30mm	1"- 11½ NPT
2807-30-20	GE 30 S /SF	30mm	1 1/4"- 11½ NPT
2807-38-20	GE 38 S /SF	38mm	1 1/4"- 11½ NPT
2807-38-24	GE 38 S /SF	38mm	1 1/2"- 11½ NPT



Код	Тип	Труба мм	Резьба
2609-08-04	GE 8 L /SF	8mm	G 1/4" UF
2609-10-04	GE 10 L /SF	10mm	G 1/4" UF
2609-22-12	GE 22 L /SF	22mm	G 3/4" UF
2609-22-16	GE 22 L /SF	22mm	G 1" UF
2609-28-20	GE 28 L /SF	28mm	G 1 1/4" UF
2609-42-24	GE 42 L /SF	42mm	G 1 1/2" UF
2809-10-04	GE 10 S /SF	10mm	G 1/4" UF
2809-10-08	GE 10 S /SF	10mm	G 1/2" UF
2809-12-04	GE 12 S /SF	12mm	G 1/4" UF
2809-12-06	GE 12 S /SF	12mm	G 3/8" UF
2809-12-08	GE 12 S /SF	12mm	G 1/2" UF
2809-16-08	GE 16 S /SF	16mm	G 1/2" UF
2809-20-08	GE 20 S /SF	20mm	G 1/2" UF
2809-20-12	GE 20 S /SF	20mm	G 3/4" UF
2809-25-16	GE 25 S /SF	25mm	G 1" UF
2809-30-20	GE 30 S /SF	30mm	G 1 1/4" UF

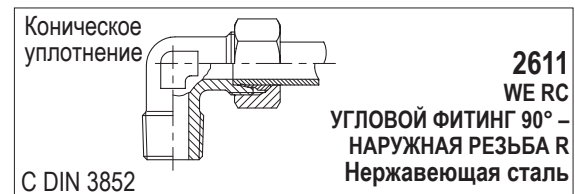

Код	Тип	Труба мм	Резьба
2611-06-02	WE 6 L /SF	6mm	R 1/8" UF
2611-06-04	WE 6 L /SF	6mm	R 1/4" UF
2611-08-02	WE 8 L /SF	8mm	R 1/8" UF
2611-08-04	WE 8 L /SF	8mm	R 1/4" UF
2611-08-06	WE 8 L /SF	8mm	R 3/8" UF
2611-08-08	WE 8 L /SF	8mm	R 1/2" UF
2611-10-02	WE 10 L /SF	10mm	R 1/8" UF
2611-10-04	WE 10 L /SF	10mm	R 1/4" UF
2611-10-06	WE 10 L /SF	10mm	R 3/8" UF
2611-10-08	WE 10 L /SF	10mm	R 1/2" UF
2611-12-02	WE 12 L /SF	12mm	R 1/8" UF
2611-12-04	WE 12 L /SF	12mm	R 1/4" UF
2611-12-06	WE 12 L /SF	12mm	R 3/8" UF
2611-12-08	WE 12 L /SF	12mm	R 1/2" UF
2611-15-06	WE 15 L /SF	15mm	R 3/8" UF
2611-15-08	WE 15 L /SF	15mm	R 1/2" UF
2611-18-08	WE 18 L /SF	18mm	R 1/2" UF
2811-06-04	WE 6 S /SF	6mm	R 1/4" UF
2811-08-04	WE 8 S /SF	8mm	R 1/4" UF
2811-08-06	WE 8 S /SF	8mm	R 3/8" UF
2811-08-08	WE 8 S /SF	8mm	R 1/2" UF
2811-10-04	WE 10 S /SF	10mm	R 1/4" UF
2811-10-06	WE 10 S /SF	10mm	R 3/8" UF
2811-10-08	WE 10 S /SF	10mm	R 1/2" UF
2811-12-06	WE 12 S /SF	12mm	R 3/8" UF
2811-12-08	WE 12 S /SF	12mm	R 1/2" UF
2811-14-08	WE 14 S /SF	14mm	R 1/2" UF
2811-16-08	WE 16 S /SF	16mm	R 1/2" UF

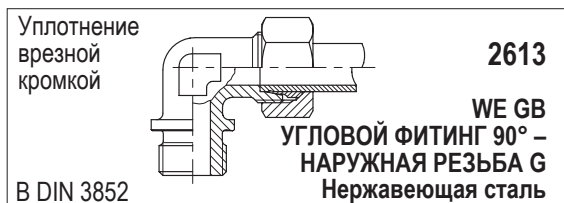

Код	Тип	Труба мм	Резьба
2613-22-12	WE 22 L /SF	22mm	G 3/4" UF
2613-28-16	WE 28 L /SF	28mm	G 1" UF
2613-35-20	WE 35 L /SF	35mm	G 1 1/4" UF
2613-42-24	WE 42 L /SF	42mm	G 1 1/2" UF
2813-20-12	WE 20 S /SF	20mm	G 3/4" UF
2813-25-16	WE 25 S /SF	25mm	G 1" UF
2813-30-20	WE 30 S /SF	30mm	G 1 1/4" UF
2813-38-24	WE 38 S /SF	38mm	G 1 1/2" UF

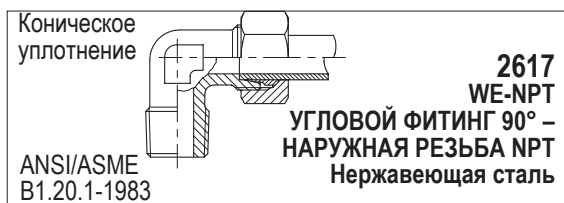

Код	Тип	Труба мм	Резьба
2617-06-02	WE 6 L /SF	6mm	1/8"- 27 NPT
2617-08-04	WE 8 L /SF	8mm	1/4"- 18 NPT
2617-10-04	WE 10 L /SF	10mm	1/4"- 18 NPT
2617-12-04	WE 12 L /SF	12mm	1/4"- 18 NPT
2617-12-06	WE 12 L /SF	12mm	3/8"- 18 NPT
2617-12-08	WE 12 L /SF	12mm	1/2"- 14 NPT
2617-15-08	WE 15 L /SF	15mm	1/2"- 14 NPT
2617-18-08	WE 18 L /SF	18mm	1/2"- 14 NPT
2617-22-12	WE 22 L /SF	22mm	3/4"- 14 NPT
2617-28-16	WE 28 L /SF	28mm	1"- 11 1/2 NPT
2617-35-20	WE 35 L /SF	35mm	1 1/4"- 11 1/2 NPT
2617-42-24	WE 42 L /SF	42mm	1 1/2"- 11 1/2 NPT
2817-06-04	WE 6 S /SF	6mm	1/4"- 18 NPT
2817-10-06	WE 10 S /SF	10mm	3/8"- 18 NPT
2817-12-06	WE 12 S /SF	12mm	3/8"- 18 NPT
2817-12-08	WE 12 S /SF	12mm	1/2"- 14 NPT
2817-14-08	WE 14 S /SF	14mm	1/2"- 14 NPT
2817-16-08	WE 16 S /SF	16mm	1/2"- 14 NPT
2817-20-12	WE 20 S /SF	20mm	3/4"- 14 NPT
2817-25-16	WE 25 S /SF	25mm	1"- 11 1/2 NPT
2817-30-20	WE 30 S /SF	30mm	1 1/4"- 11 1/2 NPT
2817-38-24	WE 38 S /SF	38mm	1 1/2"- 11 1/2 NPT



Код	Тип	Труба мм	Резьба
2621-06-02	TE 6 L /SF	6mm	R 1/8" UF
2621-08-04	TE 8 L /SF	8mm	R 1/4" UF
2621-10-04	TE 10 L /SF	10mm	R 1/4" UF
2621-12-06	TE 12 L /SF	12mm	R 3/8" UF
2621-15-08	TE 15 L /SF	15mm	R 1/2" UF
2621-18-08	TE 18 L /SF	18mm	R 1/2" UF
2821-06-04	TE 6 S /SF	6mm	R 1/4" UF
2821-08-04	TE 8 S /SF	8mm	R 1/4" UF
2821-10-06	TE 10 S /SF	10mm	R 3/8" UF
2821-12-06	TE 12 S /SF	12mm	R 3/8" UF
2821-14-08	TE 14 S /SF	14mm	R 1/2" UF
2821-16-08	TE 16 S /SF	16mm	R 1/2" UF



Код	Тип	Труба мм	Резьба
2623-22-12	TE 22 L	22mm	G 3/4" UF
2623-28-16	TE 28 L	28mm	G 1" UF
2623-35-20	TE 35 L	35mm	G 1 1/4" UF
2623-42-24	TE 42 L	42mm	G 1 1/2" UF
2823-20-12	TE 20 S	20mm	G 3/4" UF
2823-25-16	TE 25 S	25mm	G 1" UF
2823-30-20	TE 30 S	30mm	G 1 1/4" UF
2823-38-24	TE 38 S	38mm	G 1 1/2" UF

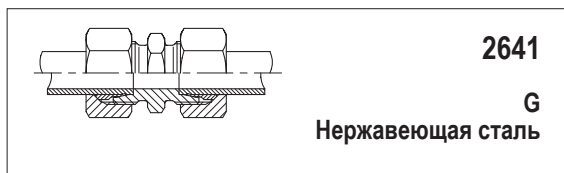

2641

G
Нержавеющая сталь

Код	Тип	Труба мм
2641-06-06	G 6 L/SF	6mm
2641-08-08	G 8 L/SF	8mm
2641-10-10	G 10 L/SF	10mm
2641-12-12	G 12 L/SF	12mm
2641-15-15	G 15 L/SF	15mm
2641-18-18	G 18 L/SF	18mm
2641-22-22	G 22 L/SF	22mm
2641-28-28	G 28 L/SF	28mm
2641-35-35	G 35 L/SF	35mm
2641-42-42	G 42 L/SF	42mm
2841-06-06	G 6 S/SF	6mm
2841-08-08	G 8 S/SF	8mm
2841-10-10	G 10 S/SF	10mm
2841-12-12	G 12 S/SF	12mm
2841-14-14	G 14 S/SF	14mm
2841-16-16	G 16 S/SF	16mm
2841-20-20	G 20 S/SF	20mm
2841-25-25	G 25 S/SF	25mm
2841-30-30	G 30 S/SF	30mm
2841-38-38	G 38 S/SF	38mm

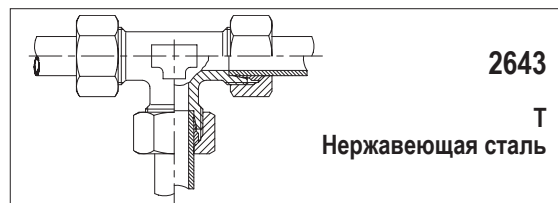

2643

T
Нержавеющая сталь

Код	Тип	Труба мм
2643-06-06	T 6 L/SF	6mm
2643-08-08	T 8 L/SF	8mm
2643-10-10	T 10 L/SF	10mm
2643-12-12	T 12 L/SF	12mm
2643-15-15	T 15 L/SF	15mm
2643-18-18	T 18 L/SF	18mm
2643-22-22	T 22 L/SF	22mm
2643-28-28	T 28 L/SF	28mm
2643-35-35	T 35 L/SF	35mm
2643-42-42	T 42 L/SF	42mm
2843-06-06	T 6 S/SF	6mm
2843-08-08	T 8 S/SF	8mm
2843-10-10	T 10 S/SF	10mm
2843-12-12	T 12 S/SF	12mm
2843-14-14	T 14 S/SF	14mm
2843-16-16	T 16 S/SF	16mm
2843-20-20	T 20 S/SF	20mm
2843-25-25	T 25 S/SF	25mm
2843-30-30	T 30 S/SF	30mm
2843-38-38	T 38 S/SF	38mm

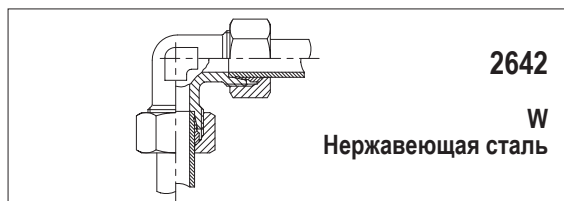

2642

W
Нержавеющая сталь

Код	Тип	Труба мм
2642-06-06	W 6 L/SF	6mm
2642-08-08	W 8 L/SF	8mm
2642-10-10	W 10 L/SF	10mm
2642-12-12	W 12 L/SF	12mm
2642-15-15	W 15 L/SF	15mm
2642-18-18	W 18 L/SF	18mm
2642-22-22	W 22 L/SF	22mm
2642-28-28	W 28 L/SF	28mm
2642-35-35	W 35 L/SF	35mm
2642-42-42	W 42 L/SF	42mm
2842-06-06	W 6 S/SF	6mm
2842-08-08	W 8 S/SF	8mm
2842-10-10	W 10 S/SF	10mm
2842-12-12	W 12 S/SF	12mm
2842-14-14	W 14 S/SF	14mm
2842-16-16	W 16 S/SF	16mm
2842-20-20	W 20 S/SF	20mm
2842-25-25	W 25 S/SF	25mm
2842-30-30	W 30 S/SF	30mm
2842-38-38	W 38 S/SF	38mm

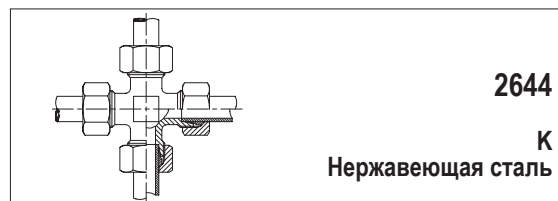

2644

K
Нержавеющая сталь

Код	Тип	Труба мм
2644-06-06	K 6 L/SF	6mm
2644-08-08	K 8 L/SF	8mm
2644-10-10	K 10 L/SF	10mm
2644-12-12	K 12 L/SF	12mm
2644-15-15	K 15 L/SF	15mm
2644-18-18	K 18 L/SF	18mm
2644-22-22	K 22 L/SF	22mm
2644-28-28	K 28 L/SF	28mm
2644-35-35	K 35 L/SF	35mm
2644-42-42	K 42 L/SF	42mm
2844-06-06	K 6 S/SF	6mm
2844-08-08	K 8 S/SF	8mm
2844-10-10	K 10 S/SF	10mm
2844-12-12	K 12 S/SF	12mm
2844-14-14	K 14 S/SF	14mm
2844-16-16	K 16 S/SF	16mm
2844-20-20	K 20 S/SF	20mm
2844-25-25	K 25 S/SF	25mm
2844-30-30	K 30 S/SF	30mm
2844-38-38	K 38 S/SF	38mm

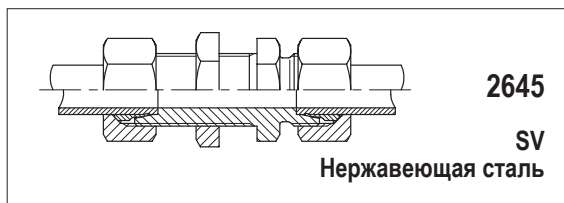

2645

SV
Нержавеющая сталь

Код	Тип	Труба мм	Резьба
2645-06-06	SV 6 L/SF	6mm	M12 x 1,5
2645-08-08	SV 8 L/SF	8mm	M14 x 1,5
2645-10-10	SV 10 L/SF	10mm	M16 x 1,5
2645-12-12	SV 12 L/SF	12mm	M18 x 1,5
2645-15-15	SV 15 L/SF	15mm	M22 x 1,5
2645-18-18	SV 18 L/SF	18mm	M26 x 1,5
2645-22-22	SV 22 L/SF	22mm	M30 x 2,0
2645-28-28	SV 28 L/SF	28mm	M36 x 2,0
2645-35-35	SV 35 L/SF	35mm	M45 x 2,0
2645-42-42	SV 42 L/SF	42mm	M52 x 2,0
2845-06-06	SV 6 S/SF	6mm	M14 x 1,5
2845-08-08	SV 8 S/SF	8mm	M16 x 1,5
2845-10-10	SV 10 S/SF	10mm	M18 x 1,5
2845-12-12	SV 12 S/SF	12mm	M20 x 1,5
2845-14-14	SV 14 S/SF	14mm	M22 x 1,5
2845-16-16	SV 16 S/SF	16mm	M24 x 1,5
2845-20-20	SV 20 S/SF	20mm	M30 x 2,0
2845-25-25	SV 25 S/SF	25mm	M36 x 2,0
2845-30-30	SV 30 S/SF	30mm	M42 x 2,0
2845-38-38	SV 38 S/SF	38mm	M52 x 2,0

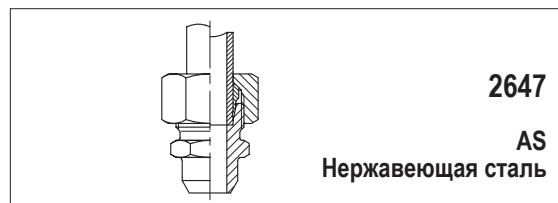

2647

AS
Нержавеющая сталь

Код	Тип	Труба мм	
2647-06-06	AS 6 L/SF	6mm	10mm
2647-08-08	AS 8 L/SF	8mm	12mm
2647-10-10	AS 10 L/SF	10mm	14mm
2647-12-12	AS 12 L/SF	12mm	16mm
2647-15-15	AS 15 L/SF	15mm	19mm
2647-18-18	AS 18 L/SF	18mm	22mm
2647-22-22	AS 22 L/SF	22mm	27mm
2647-28-28	AS 28 L/SF	28mm	32mm
2647-35-35	AS 35 L/SF	35mm	40mm
2647-42-42	AS 42 L/SF	42mm	46mm
2847-06-06	AS 6 S/SF	6mm	11mm
2847-08-08	AS 8 S/SF	8mm	13mm
2847-10-10	AS 10 S/SF	10mm	15mm
2847-12-12	AS 12 S/SF	12mm	17mm
2847-14-14	AS 14 S/SF	14mm	19mm
2847-16-16	AS 16 S/SF	16mm	21mm
2847-20-20	AS 20 S/SF	20mm	26mm
2847-25-25	AS 25 S/SF	25mm	31mm
2847-30-30	AS 30 S/SF	30mm	36mm
2847-38-38	AS 38 S/SF	38mm	44mm

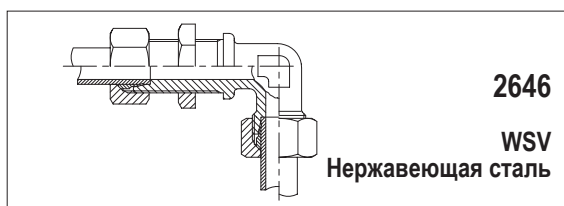

2646

WSV
Нержавеющая сталь

Код	Тип	Труба мм	Резьба
2646-06-06	WSV 6 L/SF	6mm	M12 x 1,5
2646-08-08	WSV 8 L/SF	8mm	M14 x 1,5
2646-10-10	WSV 10 L/SF	10mm	M16 x 1,5
2646-12-12	WSV 12 L/SF	12mm	M18 x 1,5
2646-15-15	WSV 15 L/SF	15mm	M22 x 1,5
2646-18-18	WSV 18 L/SF	18mm	M26 x 1,5
2646-22-22	WSV 22 L/SF	22mm	M30 x 2,0
2646-28-28	WSV 28 L/SF	28mm	M36 x 2,0
2646-35-35	WSV 35 L/SF	35mm	M45 x 2,0
2646-42-42	WSV 42 L/SF	42mm	M52 x 2,0
2846-06-06	WSV 6 S/SF	6mm	M14 x 1,5
2846-08-08	WSV 8 S/SF	8mm	M16 x 1,5
2846-10-10	WSV 10 S/SF	10mm	M18 x 1,5
2846-12-12	WSV 12 S/SF	12mm	M20 x 1,5
2846-14-14	WSV 14 S/SF	14mm	M22 x 1,5
2846-16-16	WSV 16 S/SF	16mm	M24 x 1,5
2846-20-20	WSV 20 S/SF	20mm	M30 x 2,0
2846-25-25	WSV 25 S/SF	25mm	M36 x 2,0
2846-30-30	WSV 30 S/SF	30mm	M42 x 2,0
2846-38-38	WSV 38 S/SF	38mm	M52 x 2,0

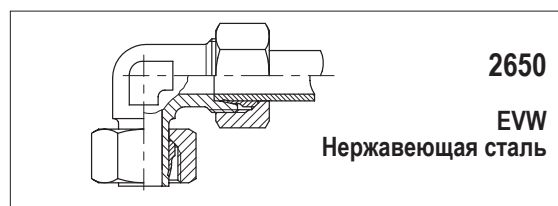

2650

EVW
Нержавеющая сталь

Код	Тип	Труба мм
2650-06-06	EVW 6 L/SF	6mm
2650-08-08	EVW 8 L/SF	8mm
2650-10-10	EVW 10 L/SF	10mm
2650-12-12	EVW 12 L/SF	12mm
2650-15-15	EVW 15 L/SF	15mm
2650-18-18	EVW 18 L/SF	18mm
2650-22-22	EVW 22 L/SF	22mm
2650-28-28	EVW 28 L/SF	28mm
2650-35-35	EVW 35 L/SF	35mm
2650-42-42	EVW 42 L/SF	42mm
2850-06-06	EVW 6 S/SF	6mm
2850-08-08	EVW 8 S/SF	8mm
2850-10-10	EVW 10 S/SF	10mm
2850-12-12	EVW 12 S/SF	12mm
2850-14-14	EVW 14 S/SF	14mm
2850-16-16	EVW 16 S/SF	16mm
2850-20-20	EVW 20 S/SF	20mm
2850-25-25	EVW 25 S/SF	25mm
2850-30-30	EVW 30 S/SF	30mm
2850-38-38	EVW 38 S/SF	38mm

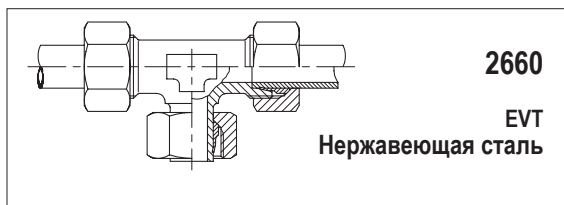

Код	Тип	Труба мм
2660-06-06	EVT 6 L/SF	6mm
2660-08-08	EVT 8 L/SF	8mm
2660-10-10	EVT 10 L/SF	10mm
2660-12-12	EVT 12 L/SF	12mm
2660-15-15	EVT 15 L/SF	15mm
2660-18-18	EVT 18 L/SF	18mm
2660-22-22	EVT 22 L/SF	22mm
2660-28-28	EVT 28 L/SF	28mm
2660-35-35	EVT 35 L/SF	35mm
2660-42-42	EVT 42 L/SF	42mm
2860-06-06	EVT 6 S/SF	6mm
2860-08-08	EVT 8 S/SF	8mm
2860-10-10	EVT 10 S/SF	10mm
2860-12-12	EVT 12 S/SF	12mm
2860-14-14	EVT 14 S/SF	14mm
2860-16-16	EVT 16 S/SF	16mm
2860-20-20	EVT 20 S/SF	20mm
2860-25-25	EVT 25 S/SF	25mm
2860-30-30	EVT 30 S/SF	30mm
2860-38-38	EVT 38 S/SF	38mm

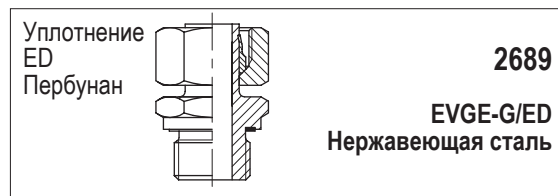

Код	Тип	Труба мм	Резьба
2689-06-02	EVGE 6 L/SF	6mm	G 1/8" UF
2689-08-04	EVGE 8 L/SF	8mm	G 1/4" UF
2689-10-04	EVGE 10 L/SF	10mm	G 1/4" UF
2689-12-06	EVGE 12 L/SF	12mm	G 3/8" UF
2689-12-08	EVGE 12 L/SF	12mm	G 1/2" UF
2689-15-08	EVGE 15 L/SF	15mm	G 1/2" UF
2689-18-08	EVGE 18 L/SF	18mm	G 1/2" UF
2689-22-12	EVGE 22 L/SF	22mm	G 3/4" UF
2689-28-16	EVGE 28 L/SF	28mm	G 1" UF
2689-35-20	EVGE 35 L/SF	35mm	G 1 1/4" UF
2689-42-24	EVGE 42 L/SF	42mm	G 1 1/2" UF
2889-06-04	EVGE 6 S/SF	6mm	G 1/4" UF
2889-08-04	EVGE 8 S/SF	8mm	G 1/4" UF
2889-10-06	EVGE 10 S/SF	10mm	G 3/8" UF
2889-12-06	EVGE 12 S/SF	12mm	G 3/8" UF
2889-12-08	EVGE 12 S/SF	12mm	G 1/2" UF
2889-14-08	EVGE 14 S/SF	14mm	G 1/2" UF
2889-16-08	EVGE 16 S/SF	16mm	G 1/2" UF
2889-20-12	EVGE 20 S/SF	20mm	G 3/4" UF
2889-25-16	EVGE 25 S/SF	25mm	G 1" UF
2889-30-20	EVGE 30 S/SF	30mm	G 1 1/4" UF
2889-38-24	EVGE 38 S/SF	38mm	G 1 1/2" UF

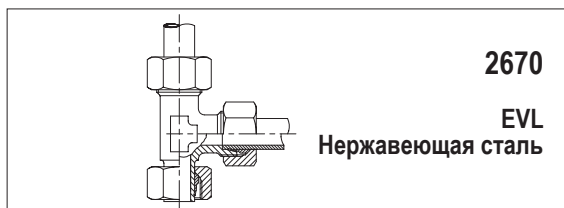

Код	Тип	Труба мм
2670-06-06	EVL 6 L/SF	6mm
2670-08-08	EVL 8 L/SF	8mm
2670-10-10	EVL 10 L/SF	10mm
2670-12-12	EVL 12 L/SF	12mm
2670-15-15	EVL 15 L/SF	15mm
2670-18-18	EVL 18 L/SF	18mm
2670-22-22	EVL 22 L/SF	22mm
2670-28-28	EVL 28 L/SF	28mm
2670-35-35	EVL 35 L/SF	35mm
2670-42-42	EVL 42 L/SF	42mm
2870-06-06	EVL 6 S/SF	6mm
2870-08-08	EVL 8 S/SF	8mm
2870-10-10	EVL 10 S/SF	10mm
2870-12-12	EVL 12 S/SF	12mm
2870-14-14	EVL 14 S/SF	14mm
2870-16-16	EVL 16 S/SF	16mm
2870-20-20	EVL 20 S/SF	20mm
2870-25-25	EVL 25 S/SF	25mm
2870-30-30	EVL 30 S/SF	30mm
2870-38-38	EVL 38 S/SF	38mm

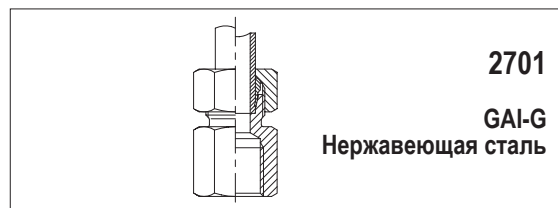

Код	Тип	Труба мм	Резьба
2701-06-02	GAI 6 L/SF	6mm	G 1/8" IF
2701-08-04	GAI 8 L/SF	8mm	G 1/4" IF
2701-10-04	GAI 10 L/SF	10mm	G 1/4" IF
2701-10-06	GAI 10 L/SF	10mm	G 3/8" IF
2701-12-06	GAI 12 L/SF	12mm	G 3/8" IF
2701-12-08	GAI 15 L/SF	15mm	G 1/2" IF
2701-15-08	GAI 15 L/SF	15mm	G 1/2" IF
2701-18-08	GAI 18 L/SF	18mm	G 1/2" IF
2701-22-12	GAI 22 L/SF	22mm	G 3/4" IF
2701-28-16	GAI 28 L/SF	28mm	G 1" IF
2701-35-20	GAI 35 L/SF	35mm	G 1 1/4" IF
2701-42-24	GAI 42 L/SF	42mm	G 1 1/2" IF
2901-06-04	GAI 6 S/SF	6mm	G 1/4" IF
2901-08-04	GAI 8 S/SF	8mm	G 1/4" IF
2901-10-06	GAI 10 S/SF	10mm	G 3/8" IF
2901-12-06	GAI 12 S/SF	12mm	G 3/8" IF
2901-14-08	GAI 14 S/SF	14mm	G 1/2" IF
2901-16-08	GAI 16 S/SF	16mm	G 1/2" IF
2901-20-12	GAI 20 S/SF	20mm	G 3/4" IF
2901-25-16	GAI 25 S/SF	25mm	G 1" IF
2901-30-20	GAI 30 S/SF	30mm	G 1 1/4" IF
2901-38-24	GAI 38 S/SF	38mm	G 1 1/2" IF

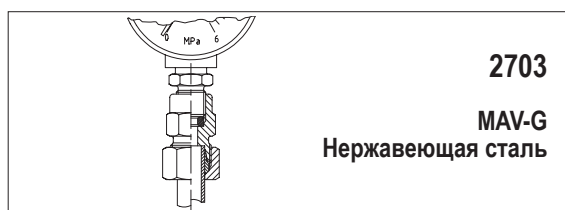

Код	Тип	Труба мм	Резьба
2703-06-04	MAV 6 L/SF	6mm	G 1/4" IF
2703-08-04	MAV 8 L/SF	8mm	G 1/4" IF
2703-10-04	MAV 10 L/SF	10mm	G 1/4" IF
2703-12-04	MAV 12 L/SF	12mm	G 1/4" IF
2903-06-08	MAV 6 S/SF	6mm	G 1/2" IF
2903-08-08	MAV 8 S/SF	8mm	G 1/2" IF
2903-10-08	MAV 10 S/SF	10mm	G 1/2" IF
2903-12-06	MAV 12 S/SF	12mm	G 3/8" IF
2903-12-08	MAV 12 S/SF	12mm	G 1/2" IF

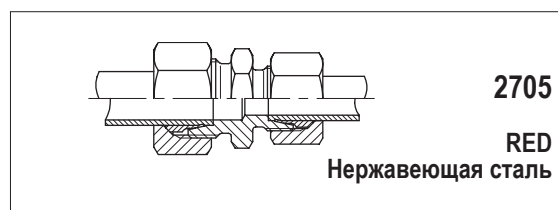

Код	Тип	Труба мм
2705-08-06	RED 8 / 6 L/SF	8 - 8mm
2705-10-06	RED 10 / 6 L/SF	10 - 6mm
2705-10-08	RED 10 / 8 L/SF	10 - 8mm
2705-12-06	RED 12 / 6 L/SF	12 - 6mm
2705-12-08	RED 12 / 8 L/SF	12 - 8mm
2705-12-10	RED 12 / 10 L/SF	12 - 10mm
2705-15-06	RED 15 / 6 L/SF	15 - 6mm
2705-15-08	RED 15 / 8 L/SF	15 - 8mm
2705-15-10	RED 15 / 10 L/SF	15 - 10mm
2705-15-12	RED 15 / 12 L/SF	15 - 12mm
2705-18-08	RED 18 / 8 L/SF	18 - 8mm
2705-18-10	RED 18 / 10 L/SF	18 - 10mm
2705-18-12	RED 18 / 12 L/SF	18 - 12mm
2705-18-15	RED 18 / 15 L/SF	18 - 15mm
2705-22-12	RED 22 / 12 L/SF	22 - 12mm
2705-22-15	RED 22 / 15 L/SF	22 - 15mm
2705-22-18	RED 22 / 18 L/SF	22 - 18mm
2705-28-12	RED 28 / 12 L/SF	28 - 12mm
2705-28-15	RED 28 / 15 L/SF	28 - 15mm
2705-28-18	RED 28 / 18 L/SF	28 - 18mm
2705-28-22	RED 28 / 22 L/SF	28 - 22mm
2705-35-28	RED 35 / 28 L/SF	35 - 28mm
2705-42-28	RED 42 / 28 L/SF	42 - 28mm
2705-42-35	RED 42 / 35 L/SF	42 - 35mm
2905-08-06	RED 8 / 6 S/SF	8 - 6mm
2905-10-06	RED 10 / 6 S/SF	10 - 6mm
2905-10-08	RED 10 / 8 S/SF	10 - 8mm
2905-12-06	RED 12 / 6 S/SF	12 - 6mm
2905-12-08	RED 12 / 8 S/SF	12 - 8mm
2905-12-10	RED 12 / 10 S/SF	12 - 10mm
2905-14-10	RED 14 / 10 S/SF	14 - 10mm
2905-14-12	RED 14 / 12 S/SF	14 - 12mm
2905-16-06	RED 16 / 10 S/SF	16 - 6mm
2905-16-08	RED 16 / 10 S/SF	16 - 8mm
2905-16-10	RED 16 / 10 S/SF	16 - 10mm
2905-16-12	RED 16 / 12 S/SF	16 - 12mm
2905-16-14	RED 16 / 14 S/SF	16 - 14mm
2905-20-10	RED 20 / 10 S/SF	20 - 10mm
2905-20-12	RED 20 / 12 S/SF	20 - 12mm
2905-20-14	RED 20 / 14 S/SF	20 - 14mm
2905-20-16	RED 20 / 16 S/SF	20 - 16mm
2905-25-16	RED 25 / 16 S/SF	25 - 16mm
2905-25-20	RED 25 / 20 S/SF	25 - 20mm
2905-30-16	RED 30 / 16 S/SF	30 - 16mm
2905-30-20	RED 30 / 20 S/SF	30 - 20mm
2905-30-25	RED 30 / 25 S/SF	30 - 25mm
2905-38-25	RED 38 / 25 S/SF	38 - 25mm
2905-38-30	RED 38 / 30 S/SF	38 - 30mm

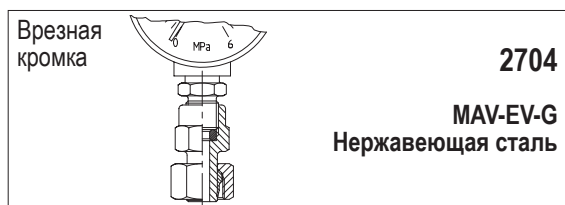

Код	Тип	Труба мм	Резьба
2704-06-04	MAV-EV 6 L/SF	6mm	G 1/4" IF
2704-08-04	MAV-EV 8 L/SF	8mm	G 1/4" IF
2704-10-04	MAV-EV 10 L/SF	10mm	G 1/4" IF
2704-12-04	MAV-EV 12 L/SF	12mm	G 1/4" IF
2904-06-08	MAV-EV 6 S/SF	6mm	G 1/2" IF
2904-08-08	MAV-EV 8 S/SF	8mm	G 1/2" IF
2904-10-08	MAV-EV 10 S/SF	10mm	G 1/2" IF
2904-12-08	MAV-EV 12 S/SF	12mm	G 1/2" IF

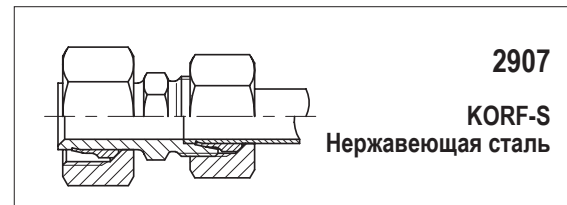
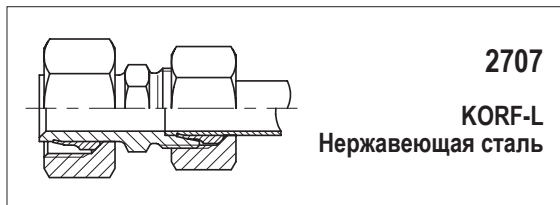

Код Тип Труба мм

2707-08-06	KOR F 8 / 6 L/SF	8 - 6mm
2707-10-06	KOR F 10 / 6 L/SF	10 - 6mm
2707-10-08	KOR F 10 / 8 L/SF	10 - 8mm
2707-12-06	KOR F 12 / 6 L/SF	12 - 6mm
2707-12-08	KOR F 12 / 8 L/SF	12 - 8mm
2707-12-10	KOR F 12 / 10 L/SF	12 - 10mm
2707-15-06	KOR F 15 / 6 L/SF	15 - 6mm
2707-15-08	KOR F 15 / 8 L/SF	15 - 8mm
2707-15-10	KOR F 15 / 10 L/SF	15 - 10mm
2707-15-12	KOR F 15 / 12 L/SF	15 - 12mm
2707-18-06	KOR F 18 / 6 L/SF	18 - 6mm
2707-18-08	KOR F 18 / 8 L/SF	18 - 8mm
2707-18-10	KOR F 18 / 10 L/SF	18 - 10mm
2707-18-12	KOR F 18 / 12 L/SF	18 - 12mm
2707-18-15	KOR F 18 / 15 L/SF	18 - 15mm
2707-22-06	KOR F 22 / 6 L/SF	22 - 6mm
2707-22-08	KOR F 22 / 8 L/SF	22 - 8mm
2707-22-10	KOR F 22 / 10 L/SF	22 - 10mm
2707-22-12	KOR F 22 / 12 L/SF	22 - 12mm
2707-22-15	KOR F 22 / 15 L/SF	22 - 15mm
2707-22-18	KOR F 22 / 18 L/SF	22 - 18mm
2707-28-06	KOR F 28 / 6 L/SF	28 - 6mm
2707-28-08	KOR F 28 / 8 L/SF	28 - 8mm
2707-28-10	KOR F 28 / 10 L/SF	28 - 10mm
2707-28-12	KOR F 28 / 12 L/SF	28 - 12mm
2707-28-15	KOR F 28 / 15 L/SF	28 - 15mm
2707-28-18	KOR F 28 / 18 L/SF	28 - 18mm
2707-28-22	KOR F 28 / 22 L/SF	28 - 22mm
2707-35-06	KOR F 35 / 6 L/SF	35 - 6mm
2707-35-08	KOR F 35 / 8 L/SF	35 - 8mm
2707-35-10	KOR F 35 / 10 L/SF	35 - 10mm
2707-35-12	KOR F 35 / 12 L/SF	35 - 12mm
2707-35-15	KOR F 35 / 15 L/SF	35 - 15mm
2707-35-18	KOR F 35 / 18 L/SF	35 - 18mm
2707-35-22	KOR F 35 / 22 L/SF	35 - 22mm
2707-35-28	KOR F 35 / 28 L/SF	35 - 28mm
2707-42-10	KOR F 42 / 10 L/SF	42 - 10mm
2707-42-12	KOR F 42 / 12 L/SF	42 - 12mm
2707-42-15	KOR F 42 / 15 L/SF	42 - 15mm
2707-42-18	KOR F 42 / 18 L/SF	42 - 18mm
2707-42-22	KOR F 42 / 22 L/SF	42 - 22mm
2707-42-28	KOR F 42 / 28 L/SF	42 - 28mm
2707-42-35	KOR F 42 / 35 L/SF	42 - 35mm

Код Тип Труба мм

2907-08-06	KOR F 8 / 6 S/SF	8 - 6mm
2907-10-06	KOR F 10 / 6 S/SF	10 - 6mm
2907-10-08	KOR F 10 / 8 S/SF	10 - 8mm
2907-12-06	KOR F 12 / 6 S/SF	12 - 6mm
2907-12-08	KOR F 12 / 8 S/SF	12 - 8mm
2907-12-10	KOR F 12 / 10 S/SF	12 - 10mm
2907-14-06	KOR F 14 / 6 S/SF	14 - 6mm
2907-14-08	KOR F 14 / 8 S/SF	14 - 8mm
2907-14-10	KOR F 14 / 10 S/SF	14 - 10mm
2907-14-12	KOR F 14 / 12 S/SF	14 - 12mm
2907-16-06	KOR F 16 / 6 S/SF	16 - 6mm
2907-16-08	KOR F 16 / 8 S/SF	16 - 8mm
2907-16-10	KOR F 16 / 10 S/SF	16 - 10mm
2907-16-12	KOR F 16 / 12 S/SF	16 - 12mm
2907-16-14	KOR F 16 / 14 S/SF	16 - 14mm
2907-16-16	KOR F 16 / 16 S/SF	16 - 16mm
2907-20-06	KOR F 20 / 6 S/SF	20 - 6mm
2907-20-08	KOR F 20 / 8 S/SF	20 - 8mm
2907-20-10	KOR F 20 / 10 S/SF	20 - 10mm
2907-20-12	KOR F 20 / 12 S/SF	20 - 12mm
2907-20-14	KOR F 20 / 14 S/SF	20 - 14mm
2907-20-16	KOR F 20 / 16 S/SF	20 - 16mm
2907-25-06	KOR F 25 / 6 S/SF	25 - 6mm
2907-25-08	KOR F 25 / 8 S/SF	25 - 8mm
2907-25-10	KOR F 25 / 10 S/SF	25 - 10mm
2907-25-12	KOR F 25 / 12 S/SF	25 - 12mm
2907-25-14	KOR F 25 / 14 S/SF	25 - 14mm
2907-25-16	KOR F 25 / 16 S/SF	25 - 16mm
2907-25-20	KOR F 25 / 20 S/SF	25 - 20mm
2907-30-06	KOR F 30 / 6 S/SF	30 - 6mm
2907-30-08	KOR F 30 / 8 S/SF	30 - 8mm
2907-30-10	KOR F 30 / 10 S/SF	30 - 10mm
2907-30-12	KOR F 30 / 12 S/SF	30 - 12mm
2907-30-14	KOR F 30 / 14 S/SF	30 - 14mm
2907-30-16	KOR F 30 / 16 S/SF	30 - 16mm
2907-30-20	KOR F 30 / 20 S/SF	30 - 20mm
2907-30-25	KOR F 30 / 25 S/SF	30 - 25mm
2907-38-06	KOR F 38 / 6 S/SF	38 - 6mm
2907-38-08	KOR F 38 / 8 S/SF	38 - 8mm
2907-38-10	KOR F 38 / 10 S/SF	38 - 10mm
2907-38-12	KOR F 38 / 12 S/SF	38 - 12mm
2907-38-14	KOR F 38 / 14 S/SF	38 - 14mm
2907-38-16	KOR F 38 / 16 S/SF	38 - 16mm
2907-38-20	KOR F 38 / 20 S/SF	38 - 20mm
2907-38-25	KOR F 38 / 25 S/SF	38 - 25mm
2907-38-30	KOR F 38 / 30 S/SF	38 - 30mm



2720

RHD

Нержавеющая сталь
НЕВОЗВРАТНЫЙ КЛАПАН
ДАВЛЕНИЯ ОТКРЫТИЯ 1 БАР

Код Тип Труба мм Резьба

2720-06-06	RHD	6 L /SF	6mm
2720-08-08	RHD	8 L /SF	8mm
2720-10-10	RHD	10 L /SF	10mm
2720-12-12	RHD	12 L /SF	12mm
2720-15-15	RHD	15 L /SF	15mm
2720-18-18	RHD	18 L /SF	18mm
2720-22-22	RHD	22 L /SF	22mm
2720-28-28	RHD	28 L /SF	28mm
2720-35-35	RHD	35 L /SF	35mm
2720-42-42	RHD	42 L /SF	42mm

2920-06-06	RHD	6 S /SF	6mm
2920-08-08	RHD	8 S /SF	8mm
2920-10-10	RHD	10 S /SF	10mm
2920-12-12	RHD	12 S /SF	12mm
2920-14-14	RHD	14 S /SF	14mm
2920-16-16	RHD	16 S /SF	16mm
2920-20-20	RHD	20 S /SF	20mm
2920-25-25	RHD	25 S /SF	25mm
2920-30-30	RHD	30 S /SF	30mm
2920-38-38	RHD	38 S /SF	38mm



Уплотнение ED

2723

RHZ-G-ED

Нержавеющая сталь
НЕВОЗВРАТНЫЙ КЛАПАН
ДАВЛЕНИЯ ОТКРЫТИЯ 1 БАР

Код Тип Труба мм Резьба

2723-06-02	RHZ	6 L /SF	6mm	G 1/8" UF
2723-08-04	RHZ	8 L /SF	8mm	G 1/4" UF
2723-10-04	RHZ	10 L /SF	10mm	G 1/4" UF
2723-12-06	RHZ	12 L /SF	12mm	G 3/8" UF
2723-15-08	RHZ	15 L /SF	15mm	G 1/2" UF
2723-18-08	RHZ	18 L /SF	18mm	G 1/2" UF
2723-22-12	RHZ	22 L /SF	22mm	G 3/4" UF
2723-28-16	RHZ	28 L /SF	28mm	G 1" UF
2723-35-20	RHZ	35 L /SF	35mm	G 1 1/4" UF
2723-42-24	RHZ	42 L /SF	42mm	G 1 1/2" UF

2923-06-04	RHZ	6 S /SF	6mm	G 1/4" UF
2923-08-04	RHZ	8 S /SF	8mm	G 1/4" UF
2923-10-06	RHZ	10 S /SF	10mm	G 3/8" UF
2923-12-06	RHZ	12 S /SF	12mm	G 3/8" UF
2923-14-08	RHZ	14 S /SF	14mm	G 1/2" UF
2923-16-08	RHZ	16 S /SF	16mm	G 1/2" UF
2923-20-12	RHZ	20 S /SF	20mm	G 3/4" UF
2923-25-16	RHZ	25 S /SF	25mm	G 1" UF
2923-30-20	RHZ	30 S /SF	30mm	G 1 1/4" UF
2923-38-24	RHZ	38 S /SF	38mm	G 1 1/2" UF



Уплотнение ED

2721

RHV-G-ED

Нержавеющая сталь
НЕВОЗВРАТНЫЙ КЛАПАН
ДАВЛЕНИЯ ОТКРЫТИЯ 1 БАР

Код Тип Труба мм Резьба

2721-06-02	RHV	6 L /SF	6mm	G 1/8" UF
2721-08-04	RHV	8 L /SF	8mm	G 1/4" UF
2721-10-04	RHV	10 L /SF	10mm	G 1/4" UF
2721-12-06	RHV	12 L /SF	12mm	G 3/8" UF
2721-15-08	RHV	15 L /SF	15mm	G 1/2" UF
2721-18-08	RHV	18 L /SF	18mm	G 1/2" UF
2721-22-12	RHV	22 L /SF	22mm	G 3/4" UF
2721-28-16	RHV	28 L /SF	28mm	G 1" UF
2721-35-20	RHV	35 L /SF	35mm	G 1 1/4" UF
2721-42-24	RHV	42 L /SF	42mm	G 1 1/2" UF

2921-06-04	RHV	6 S /SF	6mm	G 1/4" UF
2921-08-04	RHV	8 S /SF	8mm	G 1/4" UF
2921-10-06	RHV	10 S /SF	10mm	G 3/8" UF
2921-12-06	RHV	12 S /SF	12mm	G 3/8" UF
2921-14-08	RHV	14 S /SF	14mm	G 1/2" UF
2921-16-08	RHV	16 S /SF	16mm	G 1/2" UF
2921-20-12	RHV	20 S /SF	20mm	G 3/4" UF
2921-25-16	RHV	25 S /SF	25mm	G 1" UF
2921-30-20	RHV	30 S /SF	30mm	G 1 1/4" UF
2921-38-24	RHV	38 S /SF	38mm	G 1 1/2" UF



2727

RHDI-L

ОБРАТНЫЙ КЛАПАН
ДАВЛЕНИЯ ОТКРЫТИЯ 1 БАР

Код Тип Резьба

2727-04-04	RHDI /SF	G 1/4" IF
2727-06-06	RHDI /SF	G 3/8" IF
2727-08-08	RHDI /SF	G 1/2" IF
2727-12-12	RHDI /SF	G 3/4" IF
2727-16-16	RHDI /SF	G 1" IF
2727-20-20	RHDI /SF	G 1 1/4" IF
2727-24-24	RHDI /SF	G 1 1/2" IF

АЛЬТЕРНАТИВНОЕ ДАВЛЕНИЕ ОТКРЫТИЯ
0,2, 0,5, 2 и 3 БАР
ПО ЗАПРОСУ

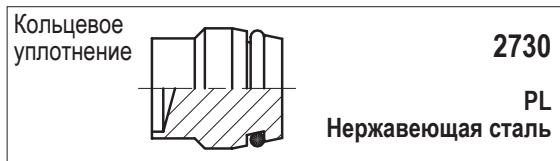

Код	Тип	Труба мм
2730-00-06	PL 6 L/S /SF	6mm
2730-00-08	PL 8 L/S /SF	8mm
2730-00-10	PL 10 L/S /SF	10mm
2730-00-12	PL 12 L/S /SF	12mm
2730-00-15	PL 15 L /SF	15mm
2730-00-18	PL 18 L /SF	18mm
2730-00-22	PL 22 L /SF	22mm
2730-00-28	PL 28 L /SF	28mm
2730-00-35	PL 35 L /SF	35mm
2730-00-42	PL 42 L /SF	42mm
2930-00-06	PL 6 S /SF	6mm
2930-00-08	PL 8 S /SF	8mm
2930-00-10	PL 10 S /SF	10mm
2930-00-12	PL 12 S /SF	12mm
2930-00-14	PL 14 S /SF	14mm
2930-00-16	PL 16 S /SF	16mm
2930-00-20	PL 20 S /SF	20mm
2930-00-25	PL 25 S /SF	25mm
2930-00-30	PL 30 S /SF	30mm
2930-00-38	PL 38 S /SF	38mm



Код	Тип	Труба мм
2749-00-06	D 6 L/S /SF	6mm
2749-00-08	D 8 L/S /SF	8mm
2749-00-10	D 10 L/S /SF	10mm
2749-00-12	D 12 L/S /SF	12mm
2749-00-15	D 15 L /SF	15mm
2749-00-18	D 18 L /SF	18mm
2749-00-22	D 22 L /SF	22mm
2749-00-28	D 28 L /SF	28mm
2749-00-35	D 35 L /SF	35mm
2749-00-42	D 42 L /SF	42mm
2949-00-14	D 14 S /SF	14mm
2949-00-16	D 16 S /SF	16mm
2949-00-20	D 20 S /SF	20mm
2949-00-25	D 25 S /SF	25mm
2949-00-30	D 30 S /SF	30mm
2949-00-38	D 38 S /SF	38mm



Код	Тип	Труба мм
2747-00-04	VH /SF	4 mm
2747-00-05	VH /SF	5 mm
2747-00-06	VH /SF	6 mm
2747-00-07	VH /SF	7 mm
2747-00-08	VH /SF	8 mm
2747-00-09	VH /SF	9 mm
2747-00-10	VH /SF	10 mm
2747-00-11	VH /SF	11 mm
2747-00-12	VH /SF	12 mm
2747-00-13	VH /SF	13 mm
2747-00-14	VH /SF	14 mm
2747-00-15	VH /SF	15 mm
2747-00-16	VH /SF	16 mm
2747-00-17	VH /SF	17 mm
2747-00-18	VH /SF	18 mm
2747-00-19	VH /SF	19 mm
2747-00-20	VH /SF	20 mm

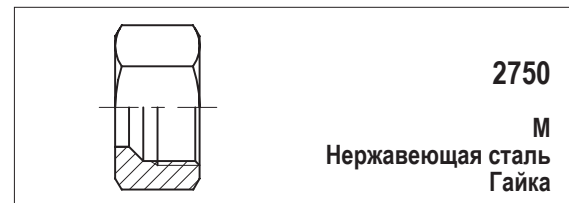

Код	Тип	Труба мм	Резьба
2750-00-06	M 6 L/SF	6mm	M12 x 1,5
2750-00-08	M 8 L/SF	8mm	M14 x 1,5
2750-00-10	M 10 L/SF	10mm	M16 x 1,5
2750-00-12	M 12 L/SF	12mm	M18 x 1,5
2750-00-15	M 15 L/SF	15mm	M22 x 1,5
2750-00-18	M 18 L/SF	18mm	M26 x 1,5
2750-00-22	M 22 L/SF	22mm	M30 x 2,0
2750-00-28	M 28 L/SF	28mm	M36 x 2,0
2750-00-35	M 35 L/SF	35mm	M42 x 2,0
2750-00-42	M 42 L/SF	42mm	M52 x 2,0
2950-00-06	M 6 S/SF	6mm	M14 x 1,5
2950-00-08	M 8 S/SF	8mm	M16 x 1,5
2950-00-10	M 10 S/SF	10mm	M18 x 1,5
2950-00-12	M 12 S/SF	12mm	M20 x 1,5
2950-00-14	M 14 S/SF	14mm	M22 x 1,5
2950-00-16	M 16 S/SF	16mm	M24 x 1,5
2950-00-20	M 20 S/SF	20mm	M30 x 2,0
2950-00-25	M 25 S/SF	25mm	M36 x 2,0
2950-00-30	M 30 S/SF	30mm	M42 x 2,0
2950-00-38	M 38 S/SF	38mm	M52 x 2,0

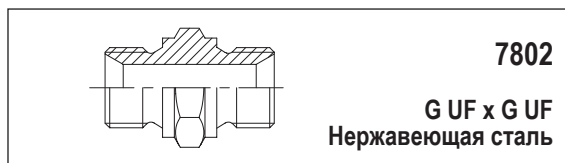

7802

G UF x G UF
Нержавеющая сталь

Код	Резьба 1		Резьба 2
7802-02-02	G 1/8" UF	x	G 1/8" UF /SF
7802-02-04	G 1/8" UF	x	G 1/4" UF /SF
7802-04-04	G 1/4" UF	x	G 1/4" UF /SF
7802-04-06	G 1/4" UF	x	G 3/8" UF /SF
7802-04-08	G 1/4" UF	x	G 1/2" UF /SF
7802-06-06	G 3/8" UF	x	G 3/8" UF /SF
7802-06-08	G 3/8" UF	x	G 1/2" UF /SF
7802-08-08	G 1/2" UF	x	G 1/2" UF /SF
7802-08-12	G 1/2" UF	x	G 3/4" UF /SF
7802-08-16	G 1/2" UF	x	G 1" UF /SF
7802-12-12	G 3/4" UF	x	G 3/4" UF /SF
7802-12-16	G 3/4" UF	x	G 1" UF /SF
7802-16-16	G 1" UF	x	G 1" UF /SF
7802-16-20	G 1" UF	x	G 1 1/4" UF /SF
7802-20-20	G 1 1/4" UF	x	G 1 1/4" UF /SF
7802-20-24	G 1 1/4" UF	x	G 1 1/2" UF /SF
7802-24-24	G 1 1/2" UF	x	G 1 1/2" UF /SF
7802-24-32	G 1 1/2" UF	x	G 2" UF /SF
7802-32-32	G 2" UF	x	G 2" UF /SF

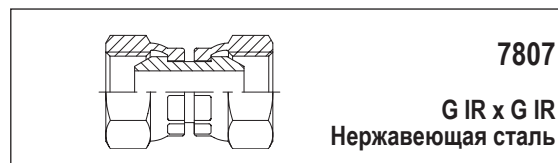

7807

G IR x G IR
Нержавеющая сталь

Код	Резьба 1		Резьба 2
7807-02-02	G 1/8" IR	x	G 1/8" IR /SF
7807-02-04	G 1/8" IR	x	G 1/4" IR /SF
7807-04-04	G 1/4" IR	x	G 1/4" IR /SF
7807-06-06	G 3/8" IR	x	G 3/8" IR /SF
7807-08-08	G 1/2" IR	x	G 1/2" IR /SF
7807-12-12	G 3/4" IR	x	G 3/4" IR /SF
7807-16-16	G 1" IR	x	G 1" IR /SF

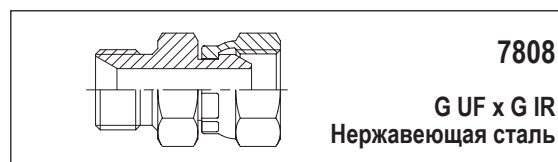

7808

G UF x G IR
Нержавеющая сталь

Код	Резьба 1		Резьба 2
7808-02-02	G 1/8" UF	x	G 1/8" IR /SF
7808-04-04	G 1/4" UF	x	G 1/4" IR /SF
7808-06-06	G 3/8" UF	x	G 3/8" IR /SF
7808-06-08	G 3/8" UF	x	G 1/2" IR /SF
7808-08-06	G 1/2" UF	x	G 3/8" IR /SF
7808-08-08	G 1/2" UF	x	G 1/2" IR /SF
7808-08-12	G 1/2" UF	x	G 3/4" IR /SF
7808-12-12	G 3/4" UF	x	G 3/4" IR /SF
7808-16-16	G 1" UF	x	G 1" IR /SF
7808-20-16	G 1 1/4" UF	x	G 1" IR /SF
7808-20-20	G 1 1/4" UF	x	G 1 1/4" IR /SF
7808-24-24	G 1 1/2" UF	x	G 1 1/2" IR /SF
7808-32-32	G 2" UF	x	G 2" IR /SF

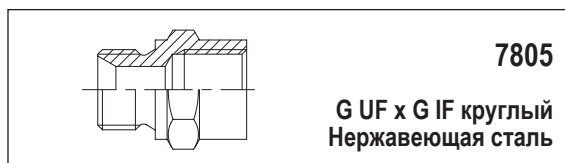

7805

G UF x G IF круглый
Нержавеющая сталь

Код	Резьба 1		Резьба 2
7805-02-02	G 1/8" UF	x	G 1/8" IF /SF
7805-04-02	G 1/4" UF	x	G 1/8" IF /SF
7805-04-04	G 1/4" UF	x	G 1/4" IF /SF
7805-04-06	G 1/4" UF	x	G 3/8" IF /SF
7805-06-04	G 3/8" UF	x	G 1/4" IF /SF
7805-06-06	G 3/8" UF	x	G 3/8" IF /SF
7805-06-08	G 3/8" UF	x	G 1/2" IF /SF
7805-08-06	G 1/2" UF	x	G 3/8" IF /SF
7805-08-08	G 1/2" UF	x	G 1/2" IF /SF
7805-08-12	G 1/2" UF	x	G 3/4" IF /SF
7805-12-08	G 3/4" UF	x	G 1/2" IF /SF
7805-12-12	G 3/4" UF	x	G 3/4" IF /SF
7805-12-16	G 3/4" UF	x	G 1" IF /SF
7805-16-16	G 1" UF	x	G 1" IF /SF
7805-16-12	G 1" UF	x	G 3/4" IF /SF
7805-20-20	G 1 1/4" UF	x	G 1 1/4" IF /SF
7805-20-24	G 1 1/4" UF	x	G 1 1/2" IF /SF
7805-24-24	G 1 1/2" UF	x	G 1 1/2" IF /SF
7805-32-32	G 2" UF	x	G 2" IF /SF

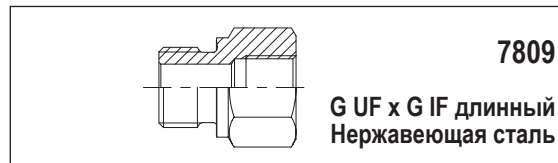

7809

G UF x G IF длинный
Нержавеющая сталь

Код	Резьба 1		Резьба 2
7809-02-04	G 1/8" UF	x	G 1/4" IF /SF
7809-04-02	G 1/4" UF	x	G 1/8" IF /SF
7809-04-06	G 1/4" UF	x	G 3/8" IF /SF
7809-04-08	G 1/4" UF	x	G 1/2" IF /SF
7809-04-12	G 1/4" UF	x	G 3/4" IF /SF
7809-06-04	G 3/8" UF	x	G 1/4" IF /SF
7809-06-08	G 3/8" UF	x	G 1/2" IF /SF
7809-08-06	G 1/2" UF	x	G 3/8" IF /SF
7809-08-12	G 1/2" UF	x	G 3/4" IF /SF
7809-08-16	G 1/2" UF	x	G 1" IF /SF
7809-12-08	G 3/4" UF	x	G 1/2" IF /SF
7809-12-16	G 3/4" UF	x	G 1" IF /SF
7809-12-20	G 3/4" UF	x	G 1 1/4" IF /SF
7809-12-24	G 3/4" UF	x	G 1 1/2" IF /SF
7809-16-12	G 1" UF	x	G 3/4" IF /SF
7809-16-20	G 1" UF	x	G 1 1/4" IF /SF
7809-16-24	G 1" UF	x	G 1 1/2" IF /SF
7809-20-16	G 1 1/4" UF	x	G 1" IF /SF



7810

**G UF x G IF короткий
Нержавеющая сталь**

Код	Резьба 1		Резьба 2
7810-06-02	G 3/8" UF	x	G 1/8" IF /SF
7810-08-04	G 1/2" UF	x	G 1/4" IF /SF
7810-12-04	G 3/4" UF	x	G 1/4" IF /SF
7810-12-06	G 3/4" UF	x	G 3/8" IF /SF
7810-12-08	G 3/4" UF	x	G 1/2" IF /SF
7810-16-06	G 1" UF	x	G 3/8" IF /SF
7810-16-08	G 1" UF	x	G 1/2" IF /SF
7810-20-12	G 1 1/4" UF	x	G 3/4" IF /SF
7810-24-16	G 1 1/2" UF	x	G 1" IF /SF
7810-32-24	G 2" UF	x	G 1 1/2" IF /SF

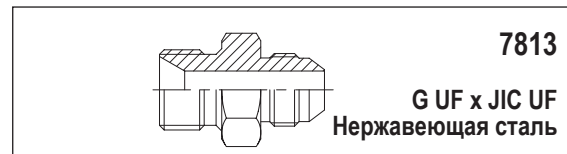

7813

**G UF x JIC UF
Нержавеющая сталь**

Код	Резьба 1		Резьба 2
7813-04-07	G 1/4" UF	x	JIC 7/16" UF /SF

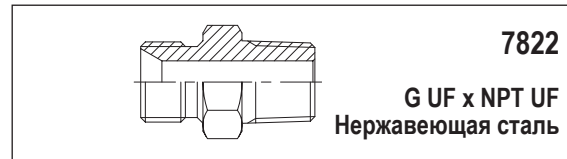

7822

**G UF x NPT UF
Нержавеющая сталь**

Код	Резьба 1		Резьба 2
7822-02-02	G 1/8" UF	x	1/8"- 27 NPT UF /SF
7822-04-04	G 1/4" UF	x	1/4"- 18 NPT UF /SF
7822-04-06	G 1/4" UF	x	3/8"- 18 NPT UF /SF
7822-06-04	G 3/8" UF	x	1/4"- 18 NPT UF /SF
7822-06-06	G 3/8" UF	x	3/8"- 18 NPT UF /SF
7822-08-04	G 1/2" UF	x	1/4"- 18 NPT UF /SF
7822-08-06	G 1/2" UF	x	3/8"- 18 NPT UF /SF
7822-08-08	G 1/2" UF	x	1/2"- 14 NPT UF /SF
7822-08-12	G 1/2" UF	x	3/4"- 14 NPT UF /SF
7822-08-16	G 1/2" UF	x	1"- 11 1/2 NPT UF /SF
7822-12-12	G 3/4" UF	x	3/4"- 14 NPT UF /SF
7822-16-12	G 1" UF	x	3/4"- 14 NPT UF /SF
7822-16-16	G 1" UF	x	1"- 11 1/2 NPT UF /SF
7822-20-16	G 1 1/4" UF	x	1"- 11 1/2 NPT UF /SF
7822-20-20	G 1 1/4" UF	x	1 1/4"- 11 1/2 NPT UF /SF
7822-24-16	G 1 1/2" UF	x	1"- 11 1/2 NPT UF /SF
7822-24-24	G 1 1/2" UF	x	1 1/2"- 11 1/2 NPT UF /SF
7822-32-32	G 2" UF	x	2"- 11 1/2 NPT UF /SF

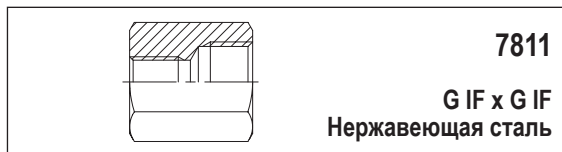

7811

**G IF x G IF
Нержавеющая сталь**

Код	Резьба 1		Резьба 2
7811-02-02	G 1/8" IF	x	G 1/8" IF /SF
7811-02-04	G 1/8" IF	x	G 1/4" IF /SF
7811-04-04	G 1/4" IF	x	G 1/4" IF /SF
7811-04-06	G 1/4" IF	x	G 3/4" IF /SF
7811-06-06	G 3/8" IF	x	G 3/8" IF /SF
7811-08-08	G 1/2" IF	x	G 1/2" IF /SF
7811-12-12	G 3/4" IF	x	G 3/4" IF /SF
7811-16-16	G 1" IF	x	G 1" IF /SF
7811-20-20	G 1 1/4" IF	x	G 1 1/4" IF /SF
7811-24-24	G 1 1/2" IF	x	G 1 1/2" IF /SF
7811-32-32	G 2" IF	x	G 2" IF /SF

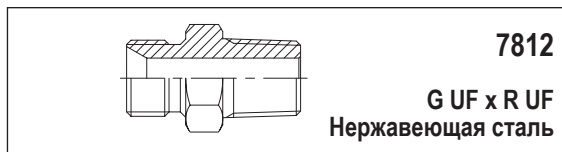

7812

**G UF x R UF
Нержавеющая сталь**

Код	Резьба 1		Резьба 2
7812-04-02	G 1/4" UF	x	R 1/8" UF /SF
7812-04-04	G 1/4" UF	x	R 1/4" UF /SF
7812-06-02	G 3/8" UF	x	R 1/8" UF /SF
7812-06-06	G 3/8" UF	x	R 3/8" UF /SF
7812-08-06	G 1/2" UF	x	R 3/8" UF /SF
7812-08-08	G 1/2" UF	x	R 1/2" UF /SF
7812-12-12	G 3/4" UF	x	R 3/4" UF /SF
7812-12-16	G 3/4" UF	x	R 1" UF /SF
7812-20-20	G 1 1/4" UF	x	R 1 1/4" UF /SF
7812-24-24	G 1 1/2" UF	x	R 1 1/2" UF /SF
7812-32-32	G 2" UF	x	R 2" UF /SF

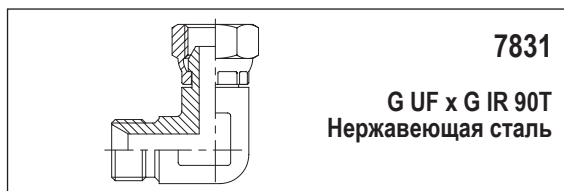

7831

G UF x G IR 90T
Нержавеющая сталь

Код	Резьба 1	Тип	Резьба 2
7831-02-02	G 1/8" UF	90T /SF	G 1/8" IR
7831-04-04	G 1/4" UF	90T /SF	G 1/4" IR
7831-06-06	G 3/8" UF	90T /SF	G 3/8" IR
7831-08-08	G 1/2" UF	90T /SF	G 1/2" IR
7831-12-12	G 3/4" UF	90T /SF	G 3/4" IR
7831-16-16	G 1" UF	90T /SF	G 1" IR
7831-20-20	G 1 1/4" UF	90T /SF	G 1 1/4" IR
7831-24-24	G 1 1/2" UF	90T /SF	G 1 1/2" IR
7831-32-32	G 2" UF	90T /SF	G 2" IR

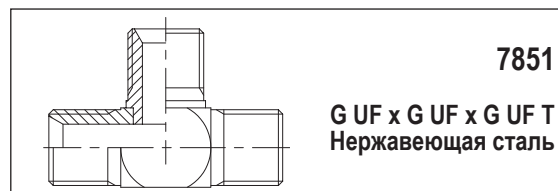

7851

G UF x G UF x G UF T
Нержавеющая сталь

Код	Резьба 1	Резьба 2	Резьба 3
7851-04-04	G 1/4" UF x	G 1/4" UF x	G 1/4" UF T /SF
7851-06-06	G 3/8" UF x	G 3/8" UF x	G 3/8" UF T /SF
7851-08-08	G 1/2" UF x	G 1/2" UF x	G 1/2" UF T /SF
7851-12-12	G 3/4" UF x	G 3/4" UF x	G 3/4" UF T /SF
7851-16-16	G 1" UF x	G 1" UF x	G 1" UF T /SF

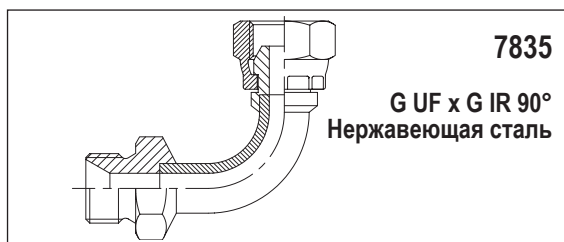

7835

G UF x G IR 90°
Нержавеющая сталь

Код	Резьба 1	Тип	Резьба 2
7835-04-04	G 1/4" UF	90° /SF	G 1/4" IR
7835-06-06	G 3/8" UF	90° /SF	G 3/8" IR
7835-08-08	G 1/2" UF	90° /SF	G 1/2" IR
7835-12-12	G 3/4" UF	90° /SF	G 3/4" IR
7835-16-16	G 1" UF	90° /SF	G 1" IR

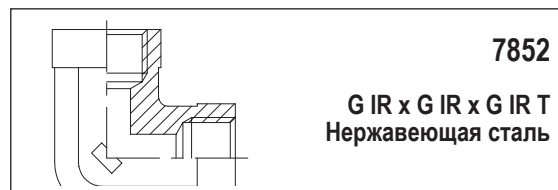

7852

G IR x G IR x G IR T
Нержавеющая сталь

Код	Резьба 1	Резьба 2	Резьба 3
7852-04-04	G 1/4" IR x	G 1/4" IR x	G 1/4" IR T /SF
7852-06-06	G 3/8" IR x	G 3/8" IR x	G 3/8" IR T /SF
7852-08-08	G 1/2" IR x	G 1/2" IR x	G 1/2" IR T /SF
7852-12-12	G 3/4" IR x	G 3/4" IR x	G 3/4" IR T /SF
7852-16-16	G 1" IR x	G 1" IR x	G 1" IR T /SF

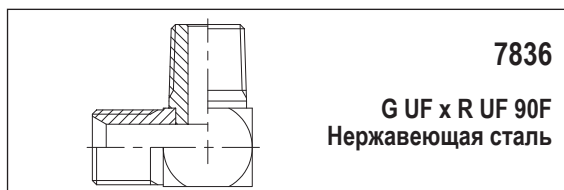

7836

G UF x R UF 90F
Нержавеющая сталь

Код	Резьба 1	Тип	Резьба 2
7836-02-02	G 1/8" UF	90F /SF	R 1/8" UF
7836-04-04	G 1/4" UF	90F /SF	R 1/4" UF
7836-06-06	G 3/8" UF	90F /SF	R 3/8" UF
7836-08-08	G 1/2" UF	90F /SF	R 1/2" UF
7836-12-12	G 3/4" UF	90F /SF	R 3/4" UF
7836-16-16	G 1" UF	90F /SF	R 1" UF

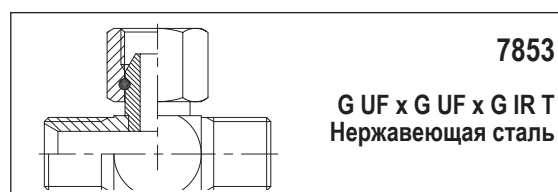

7853

G UF x G UF x G IR T
Нержавеющая сталь

Код	Резьба 1	Резьба 2	Резьба 3
7853-04-04	G 1/4" UF x	G 1/4" UF x	G 1/4" IR T /SF
7853-06-06	G 3/8" UF x	G 3/8" UF x	G 3/8" IR T /SF
7853-08-08	G 1/2" UF x	G 1/2" UF x	G 1/2" IR T /SF
7853-12-12	G 3/4" UF x	G 3/4" UF x	G 3/4" IR T /SF
7853-16-16	G 1" UF x	G 1" UF x	G 1" IR T /SF

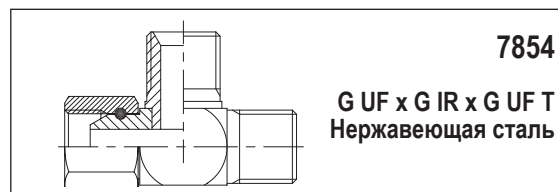

7854

G UF x G IR x G UF T
Нержавеющая сталь

Код	Резьба 1	Резьба 2	Резьба 3
7854-04-04	G 1/4" UF x	G 1/4" IR x	G 1/4" UF T /SF
7854-06-06	G 3/8" UF x	G 3/8" IR x	G 3/8" UF T /SF
7854-08-08	G 1/2" UF x	G 1/2" IR x	G 1/2" UF T /SF
7854-12-12	G 3/4" UF x	G 3/4" IR x	G 3/4" UF T /SF
7854-16-16	G 1" UF x	G 1" IR x	G 1" UF T /SF

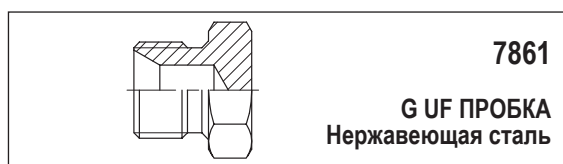

7861
G UF ПРОБКА
Нержавеющая сталь

Код	Резьба
7861-00-02	G 1/8" UF
7861-00-04	G 1/4" UF
7861-00-06	G 3/8" UF
7861-00-08	G 1/2" UF
7861-00-12	G 3/4" UF
7861-00-16	G 1" UF
7861-00-20	G 1 1/4" UF

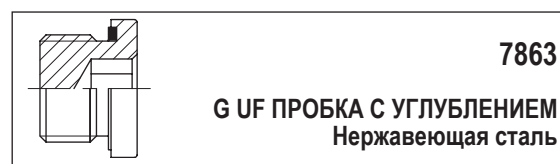

7863
G UF ПРОБКА С УГЛУБЛЕНИЕМ
Нержавеющая сталь

Код	Резьба
7863-00-02	G 1/8" UF
7863-00-04	G 1/4" UF
7863-00-06	G 3/8" UF
7863-00-08	G 1/2" UF
7863-00-12	G 3/4" UF
7863-00-16	G 1" UF
7863-00-20	G 1 1/4" UF
7863-00-24	G 1 1/2" UF

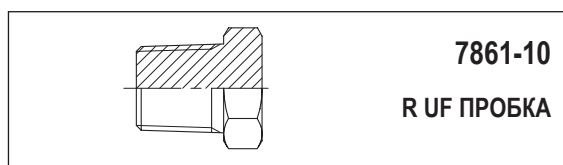

7861-10
R UF ПРОБКА

Код	Резьба
7861-10-06	R 3/8" UF
7861-10-08	R 1/2" UF

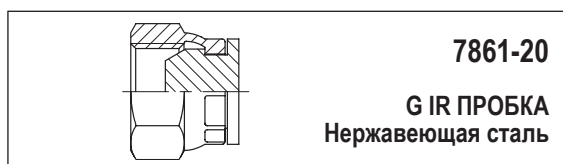

7861-20
G IR ПРОБКА
Нержавеющая сталь

Код	Резьба
7861-20-04	G 1/4" IR
7861-20-06	G 3/8" IR
7861-20-08	G 1/2" IR
7861-20-12	G 3/4" IR
7861-20-16	G 1" IR

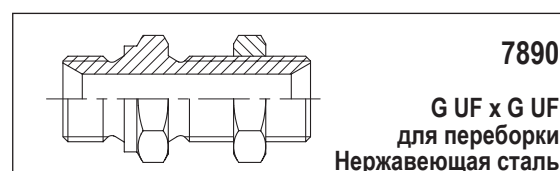

7890
G UF x G UF
для переборки
Нержавеющая сталь

Код	Резьба 1	Резьба 2
7890-04-04	G 1/4" UF	G 1/4" UF
7890-06-06	G 3/8" UF	G 3/8" UF
7890-08-08	G 1/2" UF	G 1/2" UF
7890-12-12	G 3/4" UF	G 3/4" UF



Код	Тип	Труба мм 1(мм)	Труба мм 2(мм)
7901-07-07	J G /SF	6	6
7901-09-09	J G /SF	10	10
7901-12-12	J G /SF	12	12
7901-14-14	J G /SF	14,15,16	14,15,16
7901-17-17	J G /SF	18,20	18,20
7901-21-21	J G /SF	25	25
7901-26-26	J G /SF	30,32	30,32
7901-30-30	J G /SF	38	38



Код	Тип	Труба мм (мм)
7905-07-07	J SV /SF	6
7905-08-08	J SV /SF	8
7905-09-09	J SV /SF	10
7905-12-12	J SV /SF	12
7905-14-14	J SV /SF	14,15,16
7905-17-17	J SV /SF	18,20
7905-21-21	J SV /SF	25
7905-26-26	J SV /SF	30,32
7905-30-30	J SV /SF	38



Код	Тип	Труба мм (мм)
7902-07-07	J W /SF	6
7902-08-08	J W /SF	8
7902-09-09	J W /SF	10
7902-12-12	J W /SF	12
7902-14-14	J W /SF	14,15,16
7902-21-21	J W /SF	25
7902-26-26	J W /SF	30



Код	Тип	Труба мм (мм)
7903-07-07	J T /SF	6
7903-08-08	J T /SF	8
7903-09-09	J T /SF	10
7903-12-12	J T /SF	12
7903-14-14	J T /SF	14,15,16
7903-17-17	J T /SF	18,20
7903-21-21	J T /SF	25
7903-26-26	J T /SF	30,32



Код	Тип	Труба мм (мм)
7904-12-12	J K /SF	12
7904-17-17	J K /SF	18,20
7904-26-26	J K /SF	30,32



Код	Тип	Труба мм (мм)	Резьба
7911-07-02	J GE /SF	6	1/8"- 27 NPT
7911-09-04	J GE /SF	10	1/4"- 18 NPT
7911-09-06	J GE /SF	10	3/8"- 18 NPT
7911-12-04	J GE /SF	12	1/4"- 18 NPT
7911-12-08	J GE /SF	12	1/2"- 18 NPT
7911-17-08	J GE /SF	18,20	1/2"- 18 NPT
7911-21-16	J GE /SF	25	1"-11½ NPT

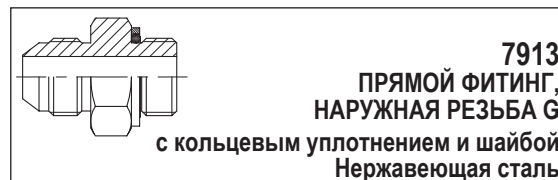

Код	Тип	Труба мм (мм)	Резьба
7913-07-02	J GE /SF	6	G 1/8" UF
7913-07-04	J GE /SF	6	G 1/4" UF
7913-07-06	J GE /SF	6	G 3/8" UF
7913-07-08	J GE /SF	6	G 1/2" UF
7913-08-04	J GE /SF	8	G 1/4" UF
7913-08-06	J GE /SF	8	G 3/8" UF
7913-09-04	J GE /SF	10	G 1/4" UF
7913-09-06	J GE /SF	10	G 3/8" UF
7913-09-08	J GE /SF	10	G 1/2" UF
7913-12-04	J GE /SF	12	G 1/4" UF
7913-12-06	J GE /SF	12	G 3/8" UF
7913-12-08	J GE /SF	12	G 1/2" UF
7913-12-12	J GE /SF	12	G 3/4" UF
7913-14-06	J GE /SF	14,15,16	G 3/8" UF
7913-14-08	J GE /SF	14,15,16	G 1/2" UF
7913-14-12	J GE /SF	14,15,16	G 3/4" UF
7913-17-08	J GE /SF	18,20	G 1/2" UF
7913-17-12	J GE /SF	18,20	G 3/4" UF
7913-17-16	J GE /SF	18,20	G 1" UF
7913-21-12	J GE /SF	25	G 3/4" UF
7913-21-16	J GE /SF	25	G 1" UF
7913-21-20	J GE /SF	25	G 1 1/4" UF
7913-26-16	J GE /SF	30,32	G 1" UF
7913-26-20	J GE /SF	30,32	G 1 1/4" UF
7913-30-20	J GE /SF	38	G 1 1/4" UF
7913-30-24	J GE /SF	38	G 1 1/2" UF

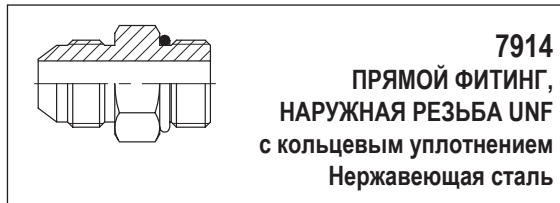

Код	Тип	Труба мм	Резьба
7914-07-07	J GE /SF	6	7/16"- 20 UNF
7914-07-09	J GE /SF	6	9/16"- 18 UNF
7914-09-09	J GE /SF	10	9/16"- 18 UNF
7914-12-09	J GE /SF	12	9/16"- 18 UNF
7914-12-12	J GE /SF	12	3/4"- 16 UNF
7914-12-14	J GE /SF	12	7/8"- 14 UNF
7914-14-14	J GE /SF	14,15,16	7/8"- 14 UNF
7914-17-14	J GE /SF	18,20	7/8"- 14 UNF
7914-17-17	J GE /SF	18,20	1 1/16"- 12 UNF
7914-21-21	J GE /SF	25	1 5/16"- 12 UNF
7914-26-26	J GE /SF	30,32	1 5/8"- 12 UNF
7914-30-30	J GE /SF	38	1 7/8"- 12 UNF

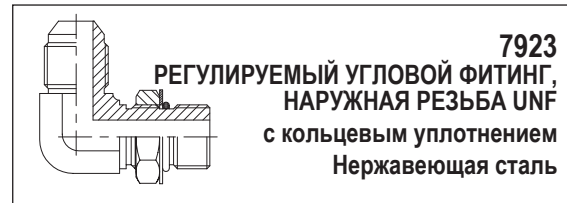

Код	Тип	Труба мм	Резьба
7923-07-07	J WE /SF	6	7/16"- 20 UNF
7923-09-09	J WE /SF	10	9/16"- 18 UNF
7923-12-12	J WE /SF	12	3/4"- 16 UNF
7923-14-14	J WE /SF	14,15,16	7/8"- 14 UNF
7923-17-17	J WE /SF	18,20	1 1/16"- 12 UNF
7923-21-21	J WE /SF	25	1 5/16"- 12 UNF
7923-26-26	J WE /SF	30,32	1 5/8"- 12 UNF
7923-30-30	J WE /SF	38	1 7/8"- 12 UNF



Код	Тип	Труба мм	Резьба
7920-07-02	J WE /SF	6	1/8"- 27 NPTF
7920-09-04	J WE /SF	10	1/4"- 18 NPTF
7920-14-08	J WE /SF	14,15,16	1/2"- 18 NPTF
7920-26-20	J WE /SF	30,32	1 1/4"- 11 1/2 NPTF



Код	Тип	Труба мм	Резьба
7951-07-04	J GAI /SF	6	G 1/4" UF
7951-08-04	J GAI /SF	8	G 1/4" UF
7951-09-06	J GAI /SF	10	G 3/8" UF
7951-12-08	J GAI /SF	12	G 1/2" UF
7951-14-08	J GAI /SF	14,15,16	G 1/2" UF
7951-17-12	J GAI /SF	18,20	G 3/4" UF
7951-21-16	J GAI /SF	25	G 1" UF
7951-26-20	J GAI /SF	30,32	G 1 1/4" UF
7951-30-24	J GAI /SF	38	G 1 1/2" UF



Код	Тип	Труба мм	Резьба
7922-07-02	J WE /SF	6	G 1/8" UF
7922-07-04	J WE /SF	6	G 1/4" UF
7922-08-04	J WE /SF	8	G 1/4" UF
7922-09-04	J WE /SF	10	G 1/4" UF
7922-09-06	J WE /SF	10	G 3/8" UF
7922-12-06	J WE /SF	12	G 3/8" UF
7922-12-08	J WE /SF	12	G 1/2" UF
7922-14-08	J WE /SF	14,15,16	G 1/2" UF
7922-17-08	J WE /SF	18,20	G 1/2" UF
7922-17-12	J WE /SF	18,20	G 3/4" UF
7922-21-16	J WE /SF	25	G 1" UF
7922-26-20	J WE /SF	30,32	G 1 1/4" UF
7922-30-24	J WE /SF	38	G 1 1/2" UF



Код	Тип	Труба мм (мм)
7959-07-07	J GII /SF	6
7959-09-09	J GII /SF	10
7959-12-12	J GII /SF	12
7959-14-14	J GII /SF	14,15,16
7959-17-17	J GII /SF	18,20



7960
УГЛОВОЙ ФИТИНГ
СО СТЯЖНОЙ ГАЙКОЙ JIS 37°
Нержавеющая сталь

Код	Тип	Труба мм (mm)
7960-07-07	J EVW /SF	6
7960-08-08	J EVW /SF	8
7960-09-09	J EVW /SF	10
7960-12-12	J EVW /SF	12
7960-14-14	J EVW /SF	14,15,16
7960-17-17	J EVW /SF	18,20
7960-21-21	J EVW /SF	25
7960-26-26	J EVW /SF	30,32
7960-30-30	J EVW /SF	38

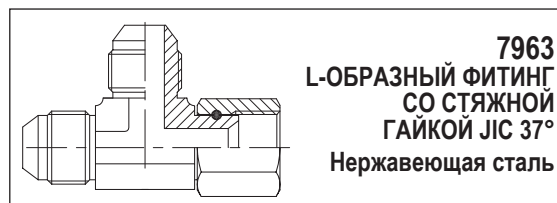

7963
L-ОБРАЗНЫЙ ФИТИНГ
СО СТЯЖНОЙ
ГАЙКОЙ JIS 37°
Нержавеющая сталь

Код	Тип	Труба мм (mm)
7963-07-07	J EVL /SF	6
7963-08-08	J EVL /SF	8
7963-09-09	J EVL /SF	10
7963-12-12	J EVL /SF	12
7963-14-14	J EVL /SF	14,15,16
7963-17-17	J EVL /SF	18,20
7963-21-21	J EVL /SF	25
7963-26-26	J EVL /SF	30,32
7963-30-30	J EVL /SF	38

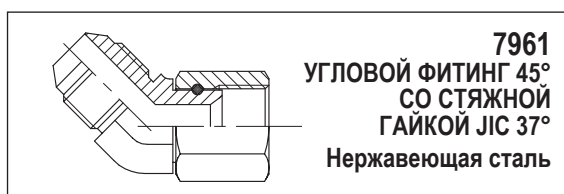

7961
УГЛОВОЙ ФИТИНГ 45°
СО СТЯЖНОЙ
ГАЙКОЙ JIS 37°
Нержавеющая сталь

Код	Тип	Труба мм (mm)
7961-07-07	J EVU /SF	6
7961-08-08	J EVU /SF	8
7961-09-09	J EVU /SF	10
7961-12-12	J EVU /SF	12
7961-14-14	J EVU /SF	14,15,16
7961-17-17	J EVU /SF	18,20
7961-21-21	J EVU /SF	25
7961-26-26	J EVU /SF	30,32
7961-30-30	J EVU /SF	38



7966
АДАПТЕР СО СТЯЖНОЙ ГАЙКОЙ JIS 37° И
НАРУЖНОЙ РЕЗЬБОЙ G
с кольцевым
уплотнением и шайбой
Нержавеющая сталь

Код	Тип	Труба мм (mm)	Резьба
7966-07-04	J EVGE /SF	6	G 1/4" UF
7966-08-04	J EVGE /SF	8	G 1/4" UF
7966-09-04	J EVGE /SF	10	G 1/4" UF
7966-09-06	J EVGE /SF	10	G 3/8" UF
7966-12-06	J EVGE /SF	12	G 3/8" UF
7966-12-08	J EVGE /SF	12	G 1/2" UF
7966-14-08	J EVGE /SF	14,15,16	G 1/2" UF
7966-17-08	J EVGE /SF	18,20	G 1/2" UF
7966-17-12	J EVGE /SF	18,20	G 3/4" UF
7966-21-12	J EVGE /SF	25	G 3/4" UF
7966-21-16	J EVGE /SF	25	G 1" UF
7966-26-20	J EVGE /SF	30,32	G 1 1/4" UF
7966-30-24	J EVGE /SF	38	G 1 1/2" UF



7962
Т-ОБРАЗНЫЙ ФИТИНГ
СО СТЯЖНОЙ
ГАЙКОЙ JIS 37°
Нержавеющая сталь

Код	Тип	Труба мм (mm)
7962-07-07	J EVT /SF	6
7962-08-08	J EVT /SF	8
7962-09-09	J EVT /SF	10
7962-12-12	J EVT /SF	12
7962-14-14	J EVT /SF	14,15,16
7962-17-17	J EVT /SF	18,20
7962-21-21	J EVT /SF	25
7962-26-26	J EVT /SF	30,32
7962-30-30	J EVT /SF	38

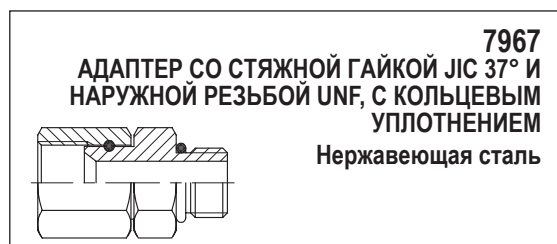

7967
АДАПТЕР СО СТЯЖНОЙ ГАЙКОЙ JIS 37° И
НАРУЖНОЙ РЕЗЬБОЙ UNF, С КОЛЬЦЕВЫМ
УПЛОТНЕНИЕМ
Нержавеющая сталь

Код	Тип	Труба мм (mm)	Резьба
7967-07-07	J EVGE /SF	6	7/16"- 20 UNF
7967-09-09	J EVGE /SF	10	9/16"- 18 UNF
7967-12-12	J EVGE /SF	12	3/4"- 16 UNF
7967-14-14	J EVGE /SF	14,15,16	7/8"- 14 UNF
7967-17-17	J EVGE /SF	18,20	1 1/16"- 12 UNF
7967-21-21	J EVGE /SF	25	1 5/16"- 12 UNF
7967-26-26	J EVGE /SF	30,32	1 5/8"- 12 UNF
7967-30-30	J EVGE /SF	38	1 7/8"- 12 UNF

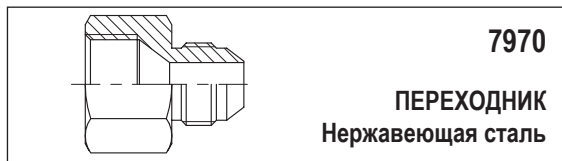

7970

ПЕРЕХОДНИК
Нержавеющая сталь

Код	Тип	Труба мм. 1(мм)	Труба мм. 2(мм)
7970-09-07	J KOR /SF	10	6
7970-09-08 *	J KOR /SF	10	8
7970-12-07	J KOR /SF	12	6
7970-12-08	J KOR /SF	12	8
7970-12-09	J KOR /SF	12	10
7970-14-09	J KOR /SF	14,15,16	10
7970-14-12 *	J KOR /SF	14,15,16	12
7970-17-08	J KOR /SF	18,20	8
7970-17-09	J KOR /SF	18,20	10
7970-17-12	J KOR /SF	18,20	12
7970-17-14 *	J KOR /SF	18,20	14,15,16
7970-21-12	J KOR /SF	25	12
7970-21-14	J KOR /SF	25	14,15,16
7970-21-17	J KOR /SF	25	18,20
7970-26-14	J KOR /SF	30,32	14,15,16
7970-26-17	J KOR /SF	30,32	18,20
7970-26-21	J KOR /SF	30,32	25
7970-30-21	J KOR /SF	38	25
7970-30-26	J KOR /SF	38	30,32

* Переходник изготовлен цельным. Для других переходников используйте гайку 7992.



7991

ПРОБКА
Нержавеющая сталь

Код	Тип	Труба мм (мм)
7991-00-07	J PLU /SF	6
7991-00-09	J PLU /SF	10
7991-00-12	J PLU /SF	12
7991-00-17	J PLU /SF	18,20
7991-00-21	J PLU /SF	25

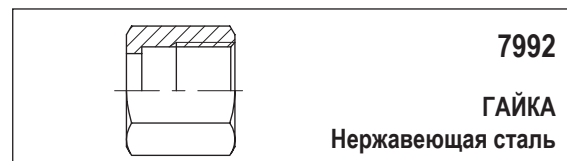

7992

ГАЙКА
Нержавеющая сталь

Код	Тип	Труба мм (мм)
7992-00-07	J M /SF	6
7992-00-08	J M /SF	8
7992-00-09	J M /SF	10
7992-00-12	J M /SF	12
7992-00-14	J M /SF	14,15,16
7992-00-17	J M /SF	18
7992-00-18	J M /SF	20
7992-00-21	J M /SF	25
7992-00-26	J M /SF	30,32
7992-00-30	J M /SF	38

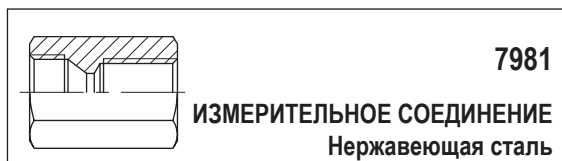

7981

ИЗМЕРИТЕЛЬНОЕ СОЕДИНЕНИЕ
Нержавеющая сталь

Код	Тип	Труба мм (мм)	Резьба
7981-08-04	J MA	8	G 1/4" IF
7981-09-04	J MA	10	G 1/4" IF
7981-12-04	J MA	12	G 1/4" IF
7981-17-04	J MA	18,20	G 1/4" IF
7981-21-04	J MA	25	G 1/4" IF



7993

ЗАЖИМНАЯ ВТУЛКА
Нержавеющая сталь

Код	Тип	Труба мм (мм)
7993-00-06	J D /SF	6
7993-00-08	J D /SF	8
7993-00-10	J D /SF	10
7993-00-12	J D /SF	12
7993-00-14	J D /SF	14
7993-00-15	J D /SF	15
7993-00-16	J D /SF	16
7993-00-18	J D /SF	18
7993-00-20	J D /SF	20
7993-00-25	J D /SF	25
7993-00-30	J D /SF	30
7993-00-32	J D /SF	32
7993-00-38	J D /SF	38

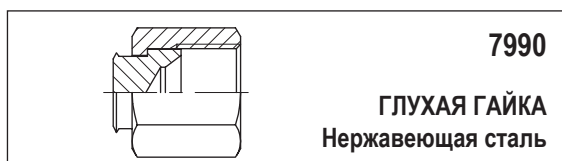

7990

ГЛУХАЯ ГАЙКА
Нержавеющая сталь

Код	Тип	Труба мм (мм)
7990-00-07	J PLI /SF	6
7990-00-08	J PLI /SF	8
7990-00-09	J PLI /SF	10
7990-00-12	J PLI /SF	12
7990-00-14	J PLI /SF	14,15,16
7990-00-17	J PLI /SF	18,20
7990-00-21	J PLI /SF	25
7990-00-26	J PLI /SF	30,32
7990-00-30	J PLI /SF	38

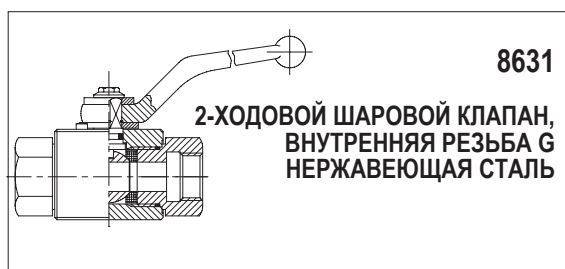

8631

2-ХОДОВОЙ ШАРОВОЙ КЛАПАН,
ВНУТРЕННЯЯ РЕЗЬБА G
НЕРЖАВЕЮЩАЯ СТАЛЬ

Код	Соединение	Размер	Раб. давление
8631-04-04	G 1/4" IF	6	50,0 MPa
8631-06-06	G 3/8" IF	10	50,0 MPa
8631-08-08	G 1/2" IF	13	50,0 MPa
8631-12-12	G 3/4" IF	20	35,0 MPa
8631-16-16	G 1" IF	25	35,0 MPa
8631-20-20	G 1 1/4" IF	32	31,5 MPa
8631-24-24	G 1 1/2" IF	40	31,5 MPa
8631-32-32	G 2" IF	50	31,5 MPa



8632

2-ХОДОВОЙ ШАРОВОЙ КЛАПАН,
СОЕДИНЕНИЕ SKL,
НЕРЖАВЕЮЩАЯ СТАЛЬ

Код	Соединение	Резьба	Размер	Раб. давление
8632-06-12	SKL 6	M12x1,5	4	50,0 MPa
8632-08-14	SKL 8	M14x1,5	6	50,0 MPa
8632-10-16	SKL 10	M16x1,5	8	50,0 MPa
8632-12-18	SKL 12	M18x1,5	10	50,0 MPa
8632-15-22	SKL 15	M22x1,5	13	50,0 MPa
8632-18-26	SKL 18	M26x1,5	16	50,0 MPa
8632-22-30	SKL 22	M30x2,0	20	35,0 MPa
8632-28-36	SKL 28	M36x2,0	25	35,0 MPa
8632-35-45	SKL 35	M42x2,0	32	31,5 MPa
8632-42-52	SKL 42	M52x2,0	40	31,5 MPa

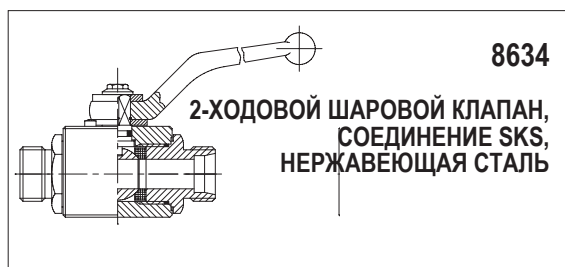

8634

2-ХОДОВОЙ ШАРОВОЙ КЛАПАН,
СОЕДИНЕНИЕ SKS,
НЕРЖАВЕЮЩАЯ СТАЛЬ

Код	Соединение	Резьба	Размер	Раб. давление
8634-08-16	SKS 8	M16x1,5	4	50,0 MPa
8634-10-18	SKS 10	M18x1,5	6	50,0 MPa
8634-12-20	SKS 12	M20x1,5	8	50,0 MPa
8634-16-24	SKS 16	M24x1,5	13	50,0 MPa
8634-20-30	SKS 20	M30x2,0	16	50,0 MPa
8634-25-36	SKS 25	M36x2,0	20	35,0 MPa
8634-30-42	SKS 30	M42x2,0	25	35,0 MPa
8634-38-52	SKS 38	M52x2,0	32	31,5 MPa



8641

3-ХОДОВОЙ РЕВЕРСИВНЫЙ КЛАПАН,
L-ОБРАЗНОЕ СВЕРЛЕНИЕ, ВНУТРЕННЯЯ
РЕЗЬБА G (BSP),
НЕРЖАВЕЮЩАЯ СТАЛЬ

Код	Соединение	Раб. давление
8641-04-04	G 1/4" IF	40,0 MPa
8641-06-06	G 3/8" IF	40,0 MPa
8641-08-08	G 1/2" IF	35,0 MPa
8641-12-12	G 3/4" IF	35,0 MPa



8642

3-ХОДОВОЙ РЕВЕРСИВНЫЙ КЛАПАН,
Т-ОБРАЗНОЕ СВЕРЛЕНИЕ, НАРУЖНАЯ
РЕЗЬБА G (BSP),
НЕРЖАВЕЮЩАЯ СТАЛЬ

Код	Соединение	Раб. давление
8642-04-04	G 1/4" IF	40,0 MPa
8642-06-06	G 3/8" IF	40,0 MPa
8642-08-08	G 1/2" IF	35,0 MPa
8642-12-12	G 3/4" IF	35,0 MPa
8642-16-16	G 1" IF	35,0 MPa



ШАРОВЫЕ КЛАПАНЫ/ИСПЫТАТЕЛЬНЫЕ НИППЕЛИ ИЗ НЕРЖАВЕЮЩЕЙ СТАЛИ

ГРУППА ПРОДУКТА 860/800

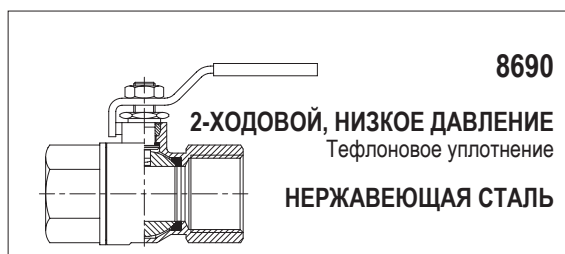

Код	Тип	Соединение	Раб. давление
8690-04-04	шаровой клапан	G 1/4" IF	6,9 МПа
8690-06-06	шаровой клапан	G 3/8" IF	6,9 МПа
8690-08-08	шаровой клапан	G 1/2" IF	6,9 МПа
8690-12-12	шаровой клапан	G 3/4" IF	6,9 МПа
8690-16-16	шаровой клапан	G 1" IF	6,9 МПа
8690-20-20	шаровой клапан	G 1 1/4" IF	6,9 МПа
8690-24-24	шаровой клапан	G 1 1/2" IF	6,9 МПа
8690-32-32	шаровой клапан	G 2" IF	6,9 МПа

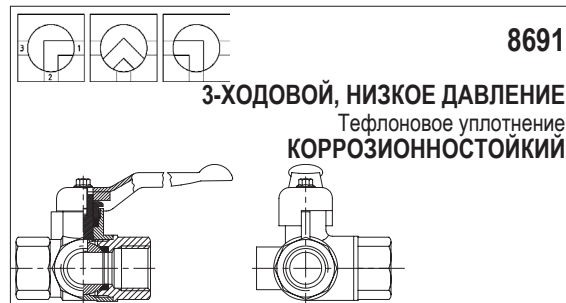

Код	Тип	Соединение	Раб. давление
8691-06-06	шаровой клапан	G 3/8" IF	6,9 МПа
8691-08-08	шаровой клапан	G 1/2" IF	6,9 МПа
8691-12-12	шаровой клапан	G 3/4" IF	6,9 МПа
8691-16-16	шаровой клапан	G 1" IF	6,9 МПа
8691-20-20	шаровой клапан	G 1 1/4" IF	6,9 МПа
8691-24-24	шаровой клапан	G 1 1/2" IF	6,9 МПа
8691-32-32	шаровой клапан	G 2" IF	6,9 МПа

ПРИМЕЧАНИЕ! Для низкого давления используйте шаровые клапаны 8690 и 8691: более низкое давление для повышенных температур.



Код	Тип	Соединение
8301-90-02	M16 x 2	G 1/8" UF
8301-90-04	M16 x 2	G 1/4" UF

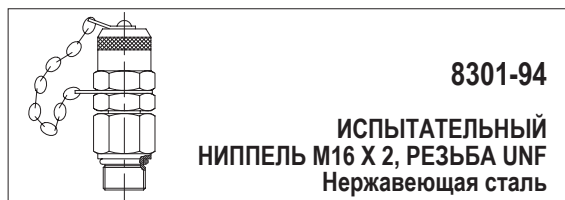

Код	Тип	Соединение
8301-94-09	M16 x 2	9/16"-18 UNF

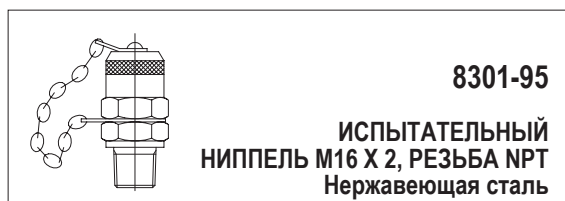

Код	Тип	Соединение
8301-95-04	M16 x 2	1/4"-18 NPT

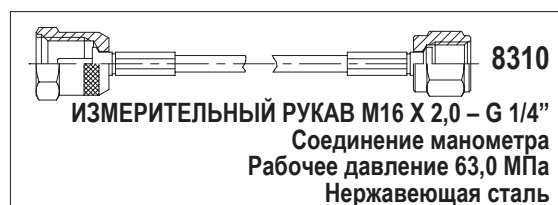

Код	Длина
8310-04-00	L = 400 mm
8310-10-00	L = 1000 mm
8310-15-00	L = 1500 mm
8310-20-00	L = 2000 mm
8310-32-00	L = 3200 mm
8310-40-00	L = 4000 mm

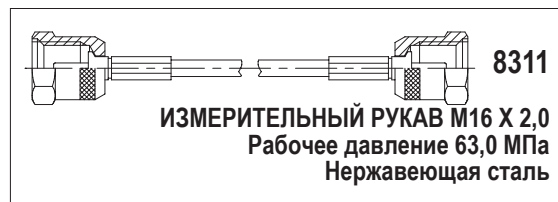

Код	Длина
8311-04-00	L = 400 mm
8311-10-00	L = 1000 mm
8311-15-00	L = 1500 mm
8311-20-00	L = 2000 mm
8311-32-00	L = 3200 mm
8311-40-00	L = 4000 mm